

Francie

TOP



Sizes 18-34
with cup sizes A-H

5/8 inch (in) (1.5 cm) seam allowances are included on all pattern pieces.

**SIZE 18-34
PATTERN
SIZE KEY**

- 18 - - - - -
- 20 ·····
- 22 ·····
- 24 - - - - -
- 26 ·····
- 28 - - - - -
- 30 ·····
- 32 ·····
- 34 - - - - -

SYMBOL KEY

grainline arrow



match point/
placement mark



© 2023 Charm Patterns
by Gertie. Distribution
and Commercial Use
Prohibited.

PAGE

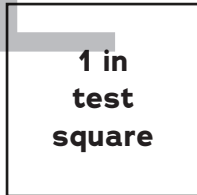

1

FOLD BACK THIS MARGIN

FOLD BACK THIS MARGIN

A1

PAGE

2

FOLD BACK THIS MARGIN

A1

FOLD BACK THIS MARGIN

34

32

A2

PAGE 3

FOLD BACK THIS MARGIN

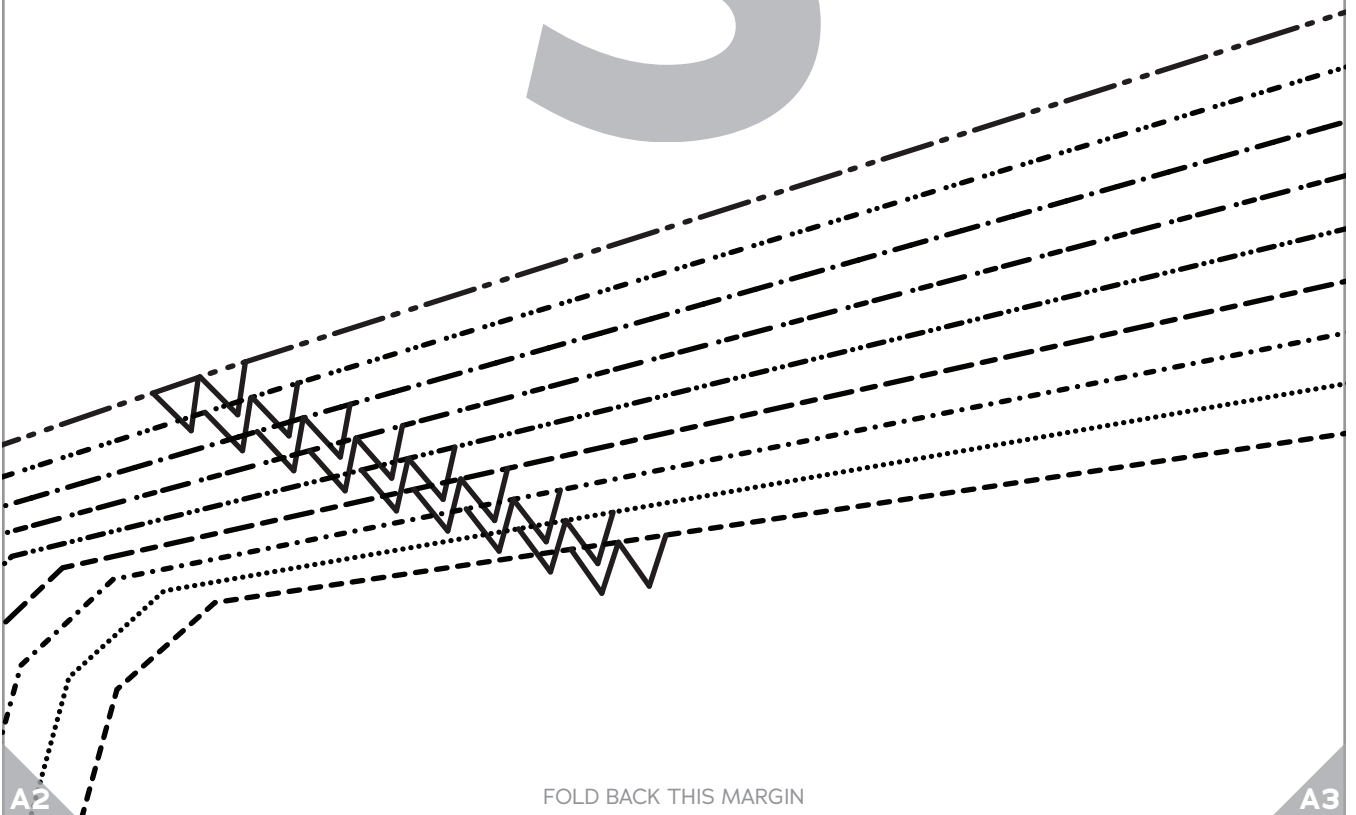

A2

FOLD BACK THIS MARGIN

A3

PAGE

4

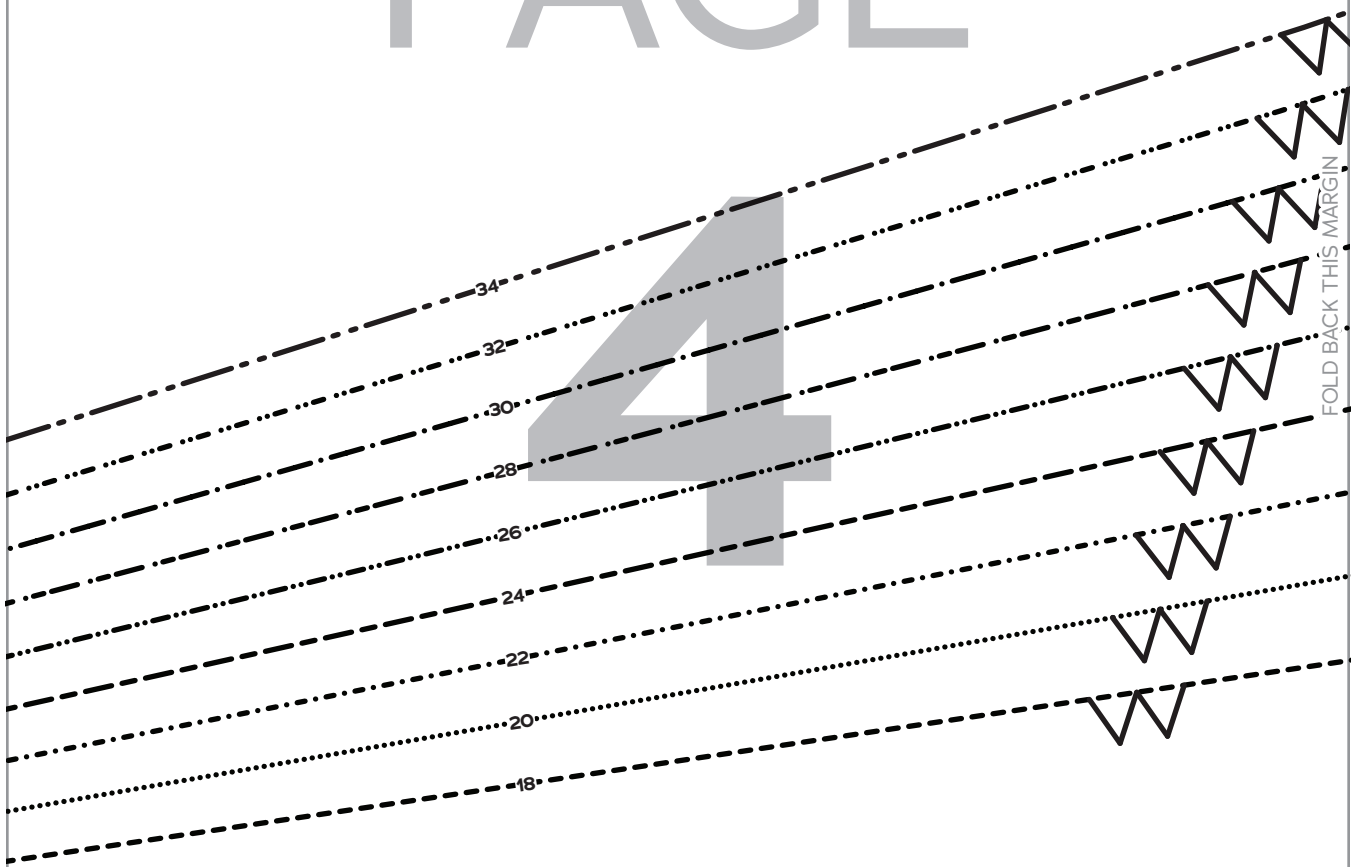

FOLD BACK THIS MARGIN

A3

FOLD BACK THIS MARGIN

A4

PAGE

5

FOLD BACK THIS MARGIN

A4

FOLD BACK THIS MARGIN

A5

PAGE

6

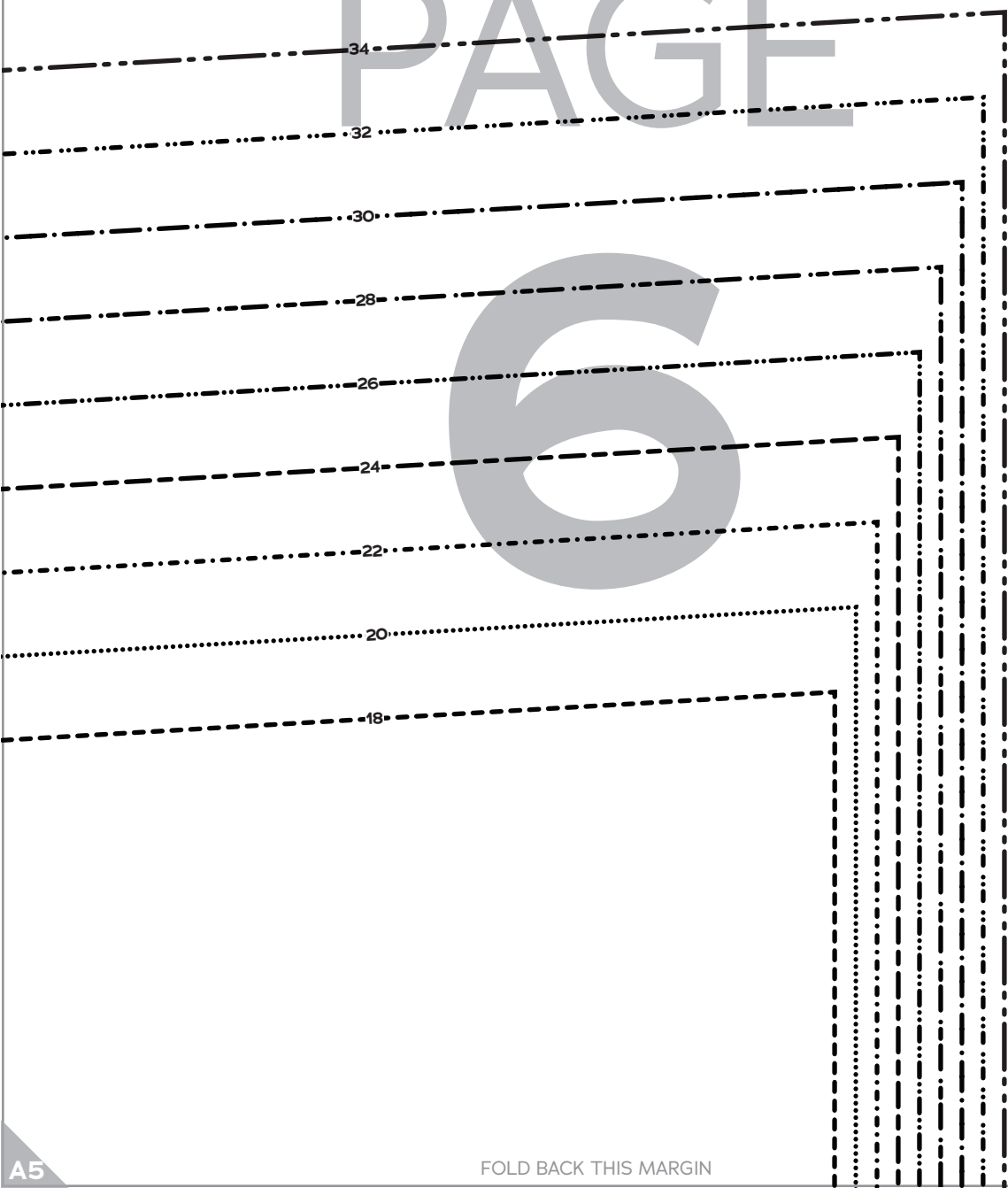

FOLD BACK THIS MARGIN

A5

FOLD BACK THIS MARGIN

A6

PAGE 7

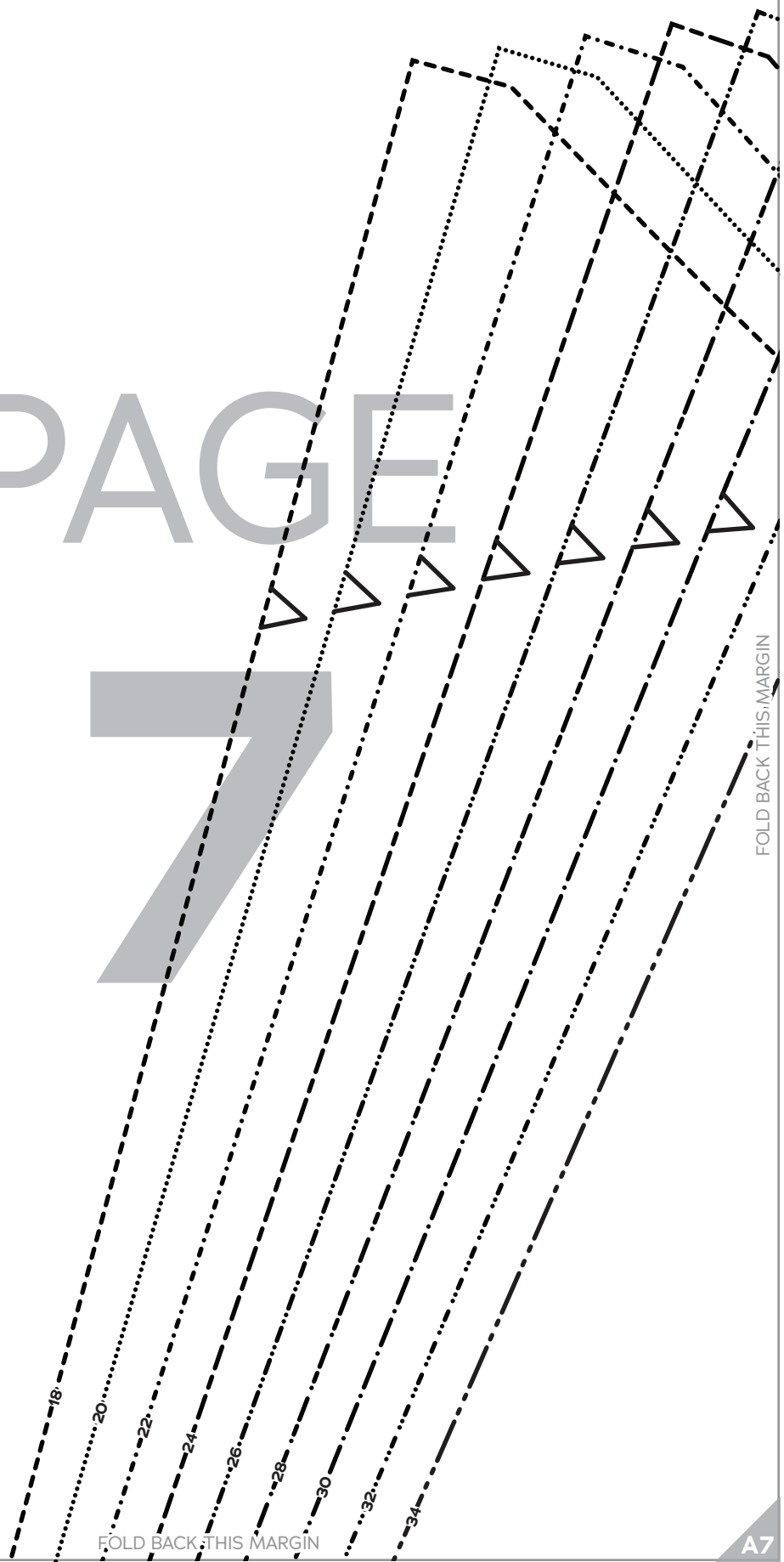

FOLD BACK THIS MARGIN

A6

FOLD BACK THIS MARGIN

A7

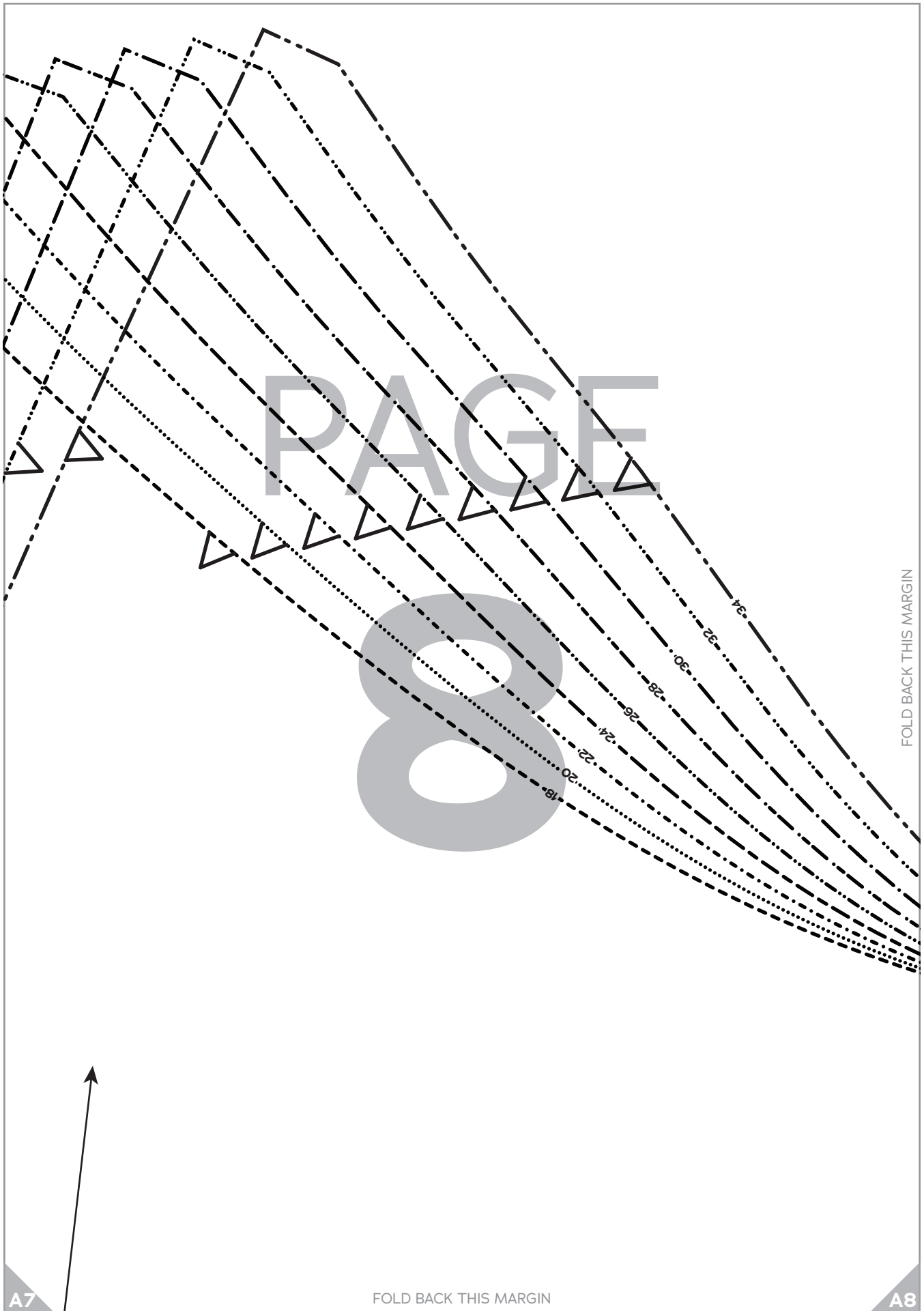

A7

FOLD BACK THIS MARGIN

A8

PAGE

9

FOLD BACK THIS MARGIN

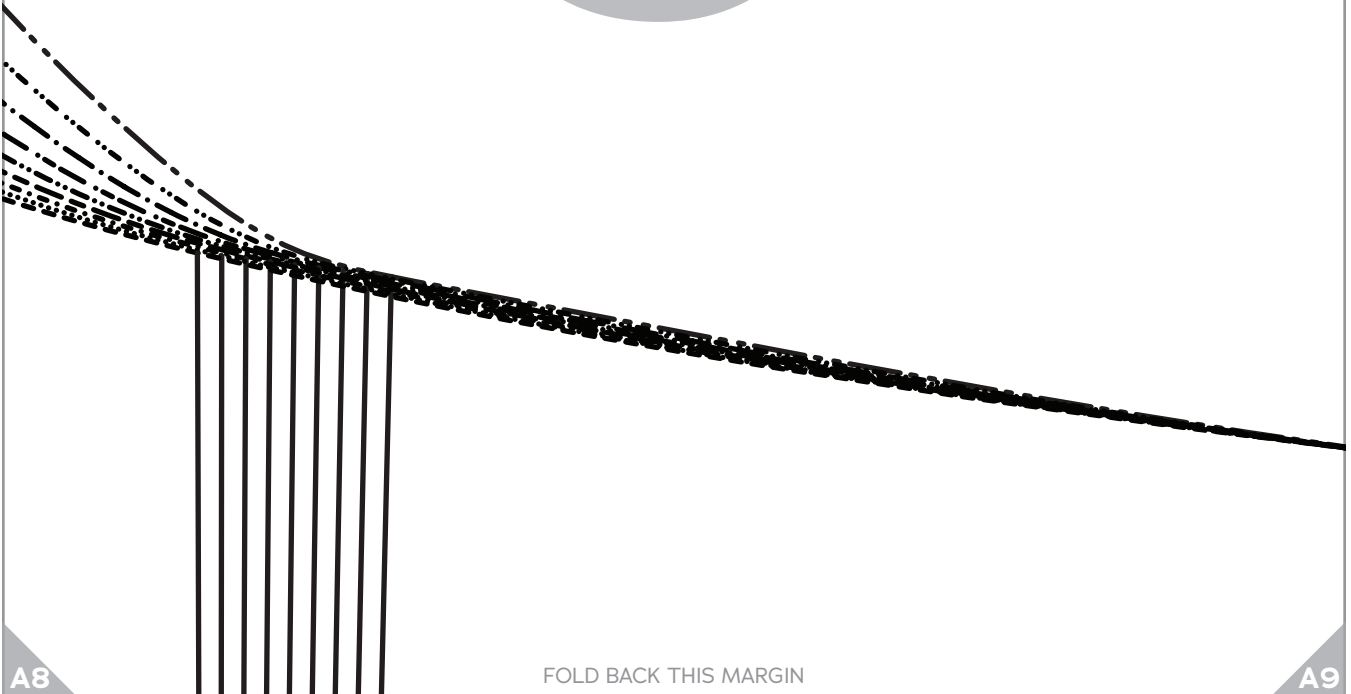

A8

FOLD BACK THIS MARGIN

A9

PAGE

10

FOLD BACK THIS MARGIN

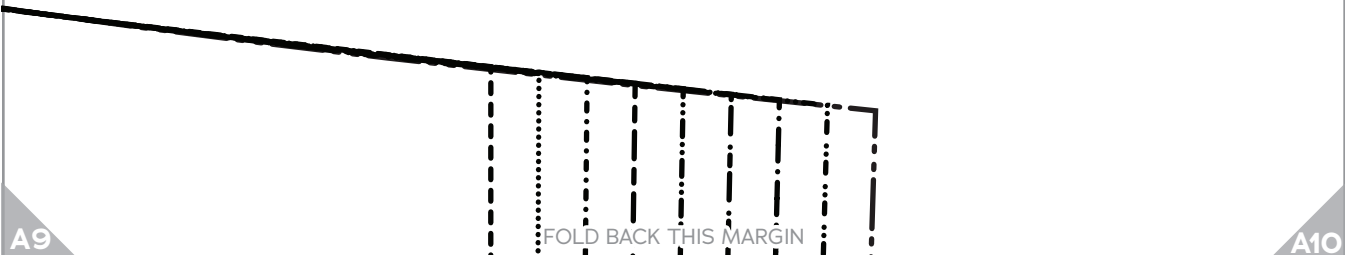

A9

FOLD BACK THIS MARGIN

A10

PAGE

11

FOLD BACK THIS MARGIN

FOLD LINE

18
20
22
24
26
28
30
32
34



D

A10

FOLD BACK THIS MARGIN

A11

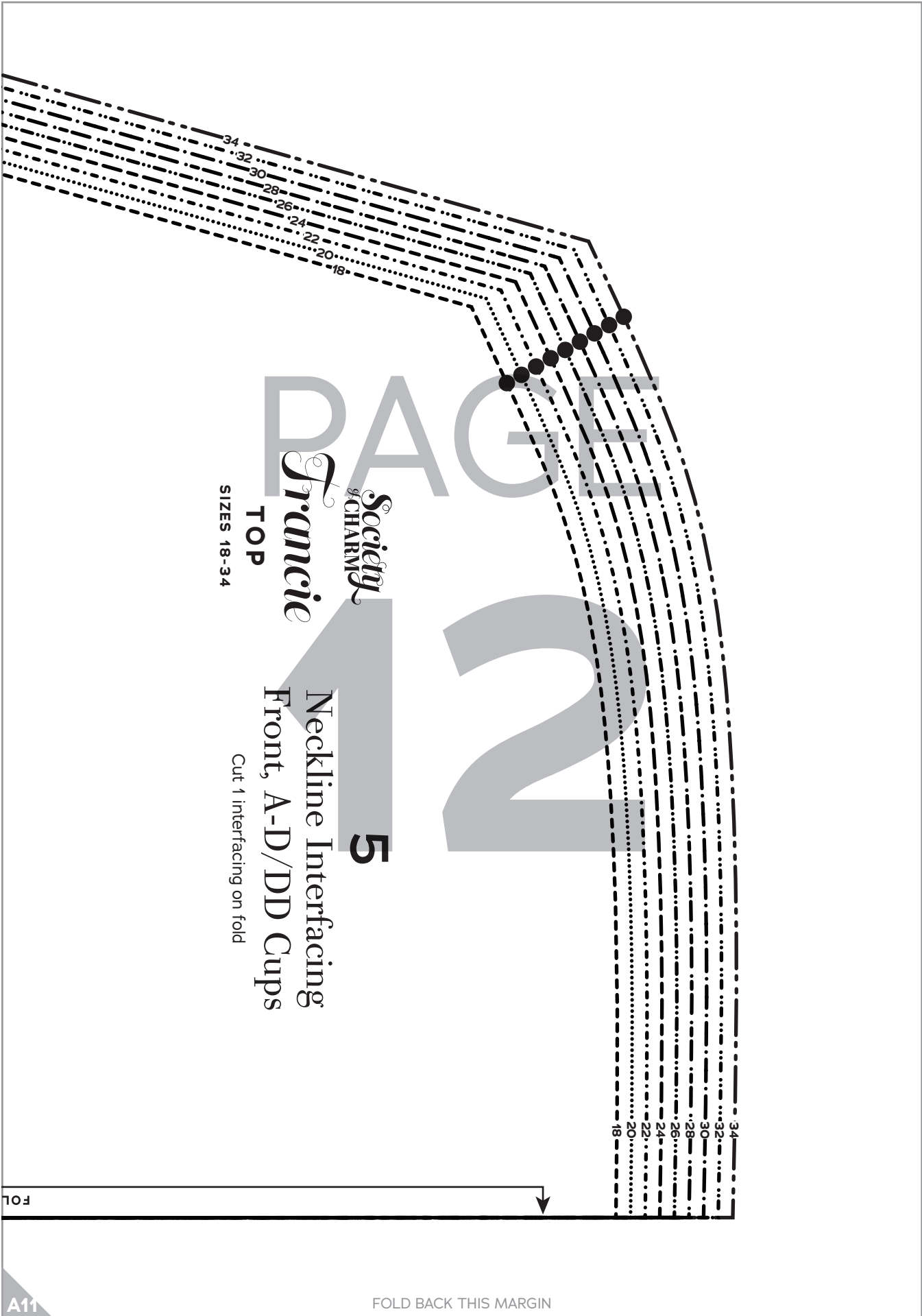

SIZES 18-34

TOP

Neckline Interfacing
Front, A-D/DD Cups

Cut 1 interfacing on fold

5

FOLD

FOLD BACK THIS MARGIN

A11

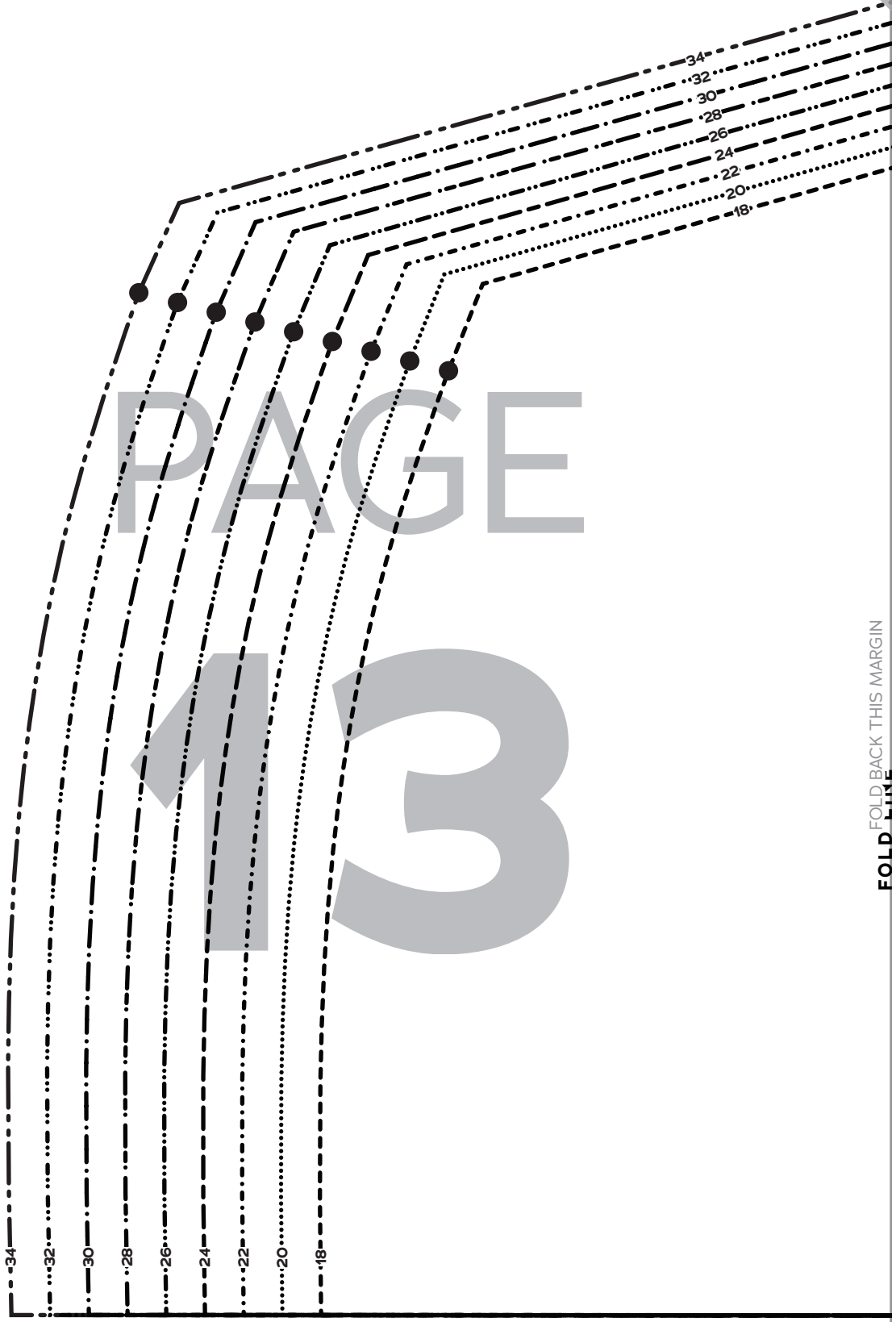

PAGE
13

FOLD BACK THIS MARGIN
FOLD LINE

FOLD BACK THIS MARGIN

A1

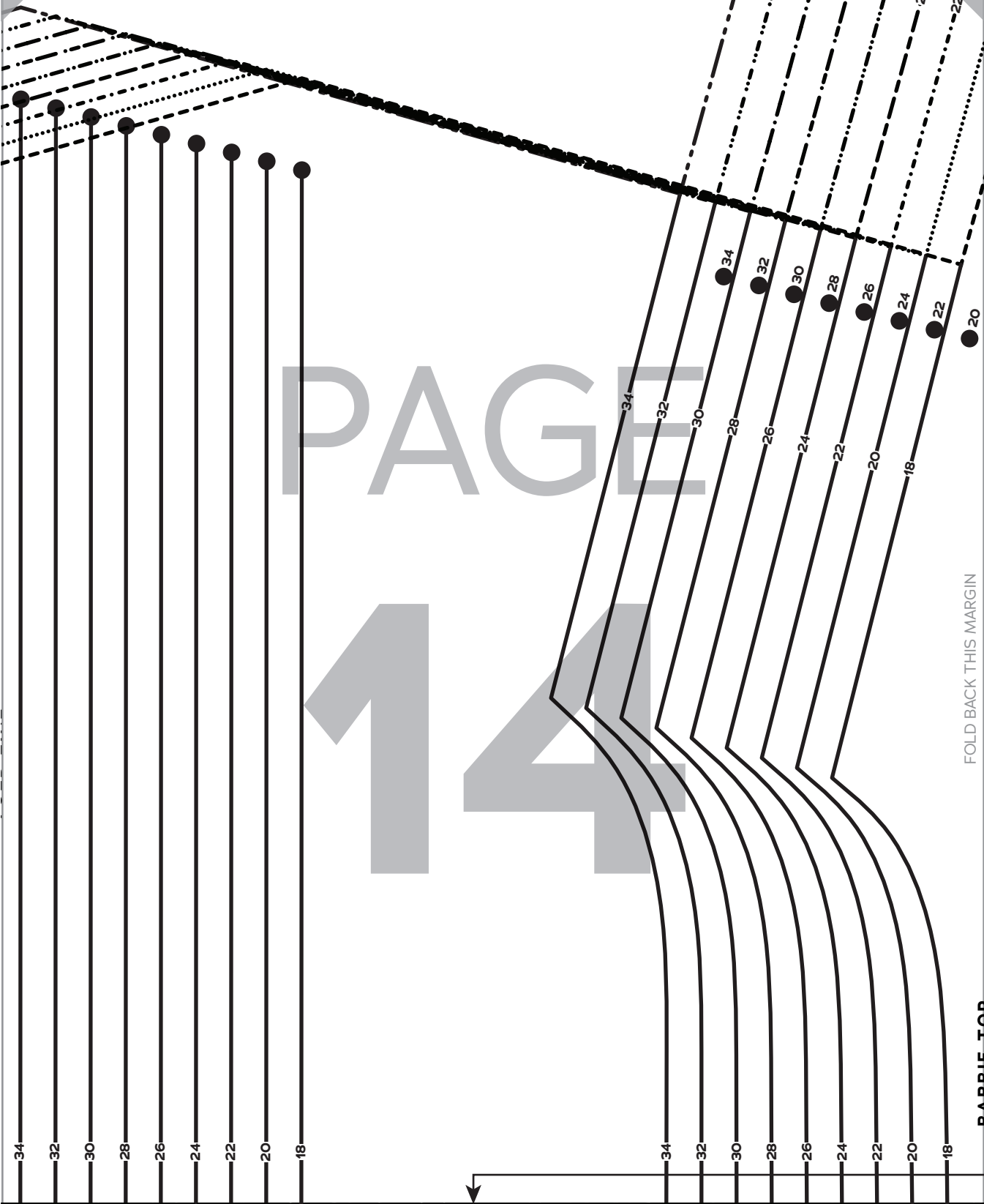

B1

FOLD BACK THIS MARGIN

B2

A2

A3

18

PAGE

15

FOLD BACK THIS MARGIN

PARTIAL TOP
ALTERNATIVE
NECKLINE

a

B2

FOLD BACK THIS MARGIN

B3

A3

A4

Society
of CHARM
Francie

TOP

SIZES 18-34

2

Top Back
Cut 1 fabric on fold

PAGE

16

FOLD BACK THIS MARGIN

FOL

B3

FOLD BACK THIS MARGIN

B4

A4

A5

PAGE

WAISTLINE

17

18
20
22
24
26
28
30
32
34

FOLD BACK THIS MARGIN

B4

FOLD BACK THIS MARGIN

B5

A5

A6

PAGE 18

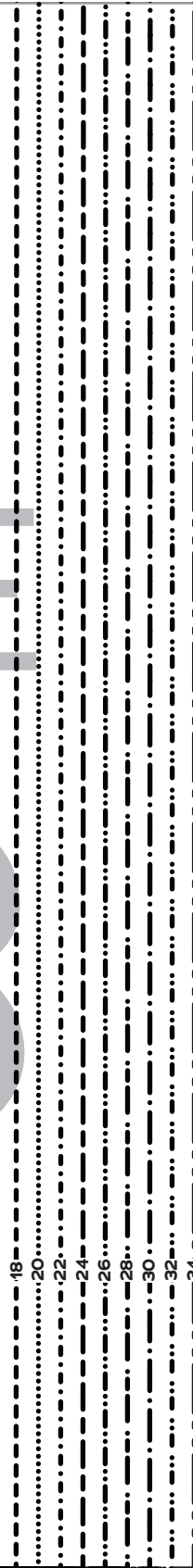

FOLD BACK THIS MARGIN

B5

FOLD BACK THIS MARGIN

B6

A6

A7

PAGE 19

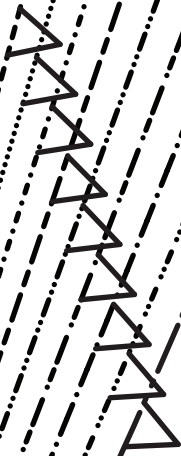

FOLD BACK THIS MARGIN

B6

FOLD BACK THIS MARGIN

B7

A7

A8

GRAINLINE

Sleeve Front,
A-D/DD Cups
Cut 2 fabric

3

SIZES 18-34

Frannie
TOP
Society
of CHARM
PAGE

20

FOLD BACK THIS MARGIN

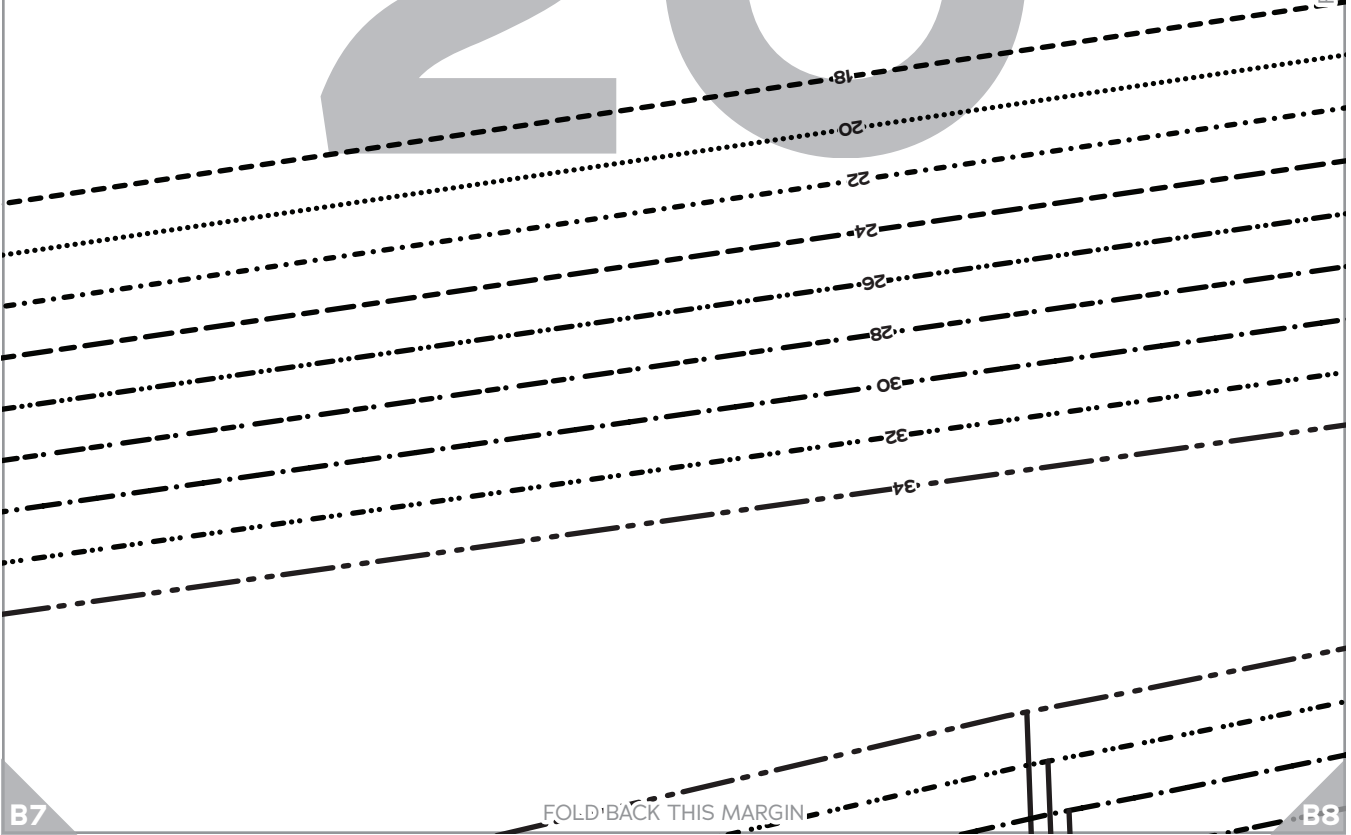

B7

FOLD BACK THIS MARGIN

B8

A8

A9

THREE-QUARTER SLEEVE CUTTING LINE

18
20
22
24
26
28
30
32
34

PAGE

21

FOLD BACK THIS MARGIN

B8

B9

FOLD BACK THIS MARGIN

A9

A10

PAGE

22

18

20

22

24

26

28

30

32

34

FOLD BACK THIS MARGIN

FOLD BACK THIS MARGIN

B9

B10

A10

A11

PAGE
23

FOLD BACK THIS MARGIN

FOLD LINE

34
32
30
28
26
24
22
20
18

B10

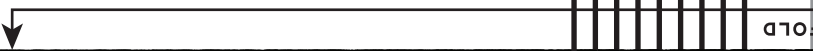

FOLD BACK THIS MARGIN

B11

A11

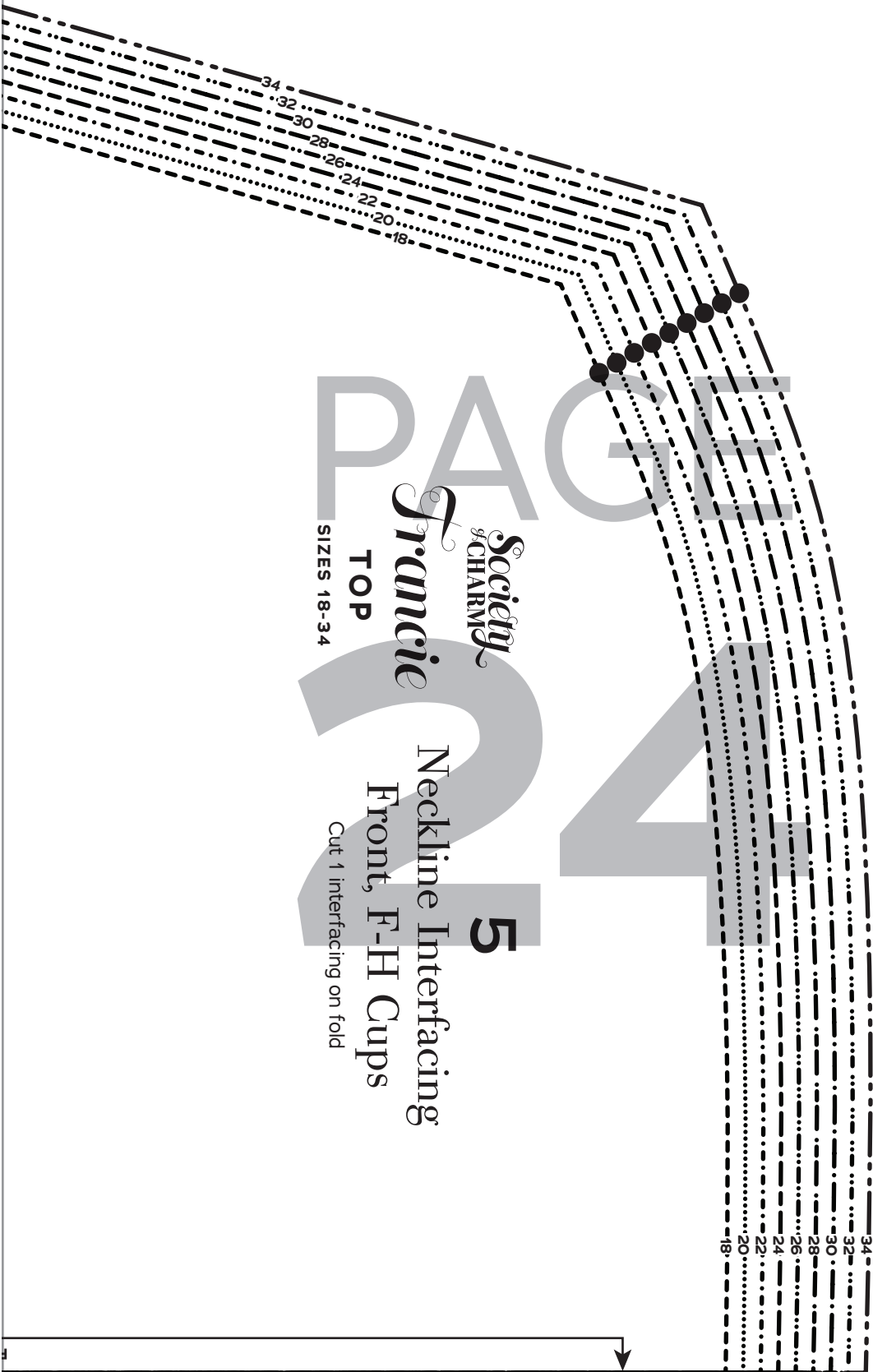

Society of CHARM

Francie

TOP

SIZES 18-34

5

Neckline Interfacing
Front, F-H Cups

Cut 1 interfacing on fold

B11

FOLD BACK THIS MARGIN

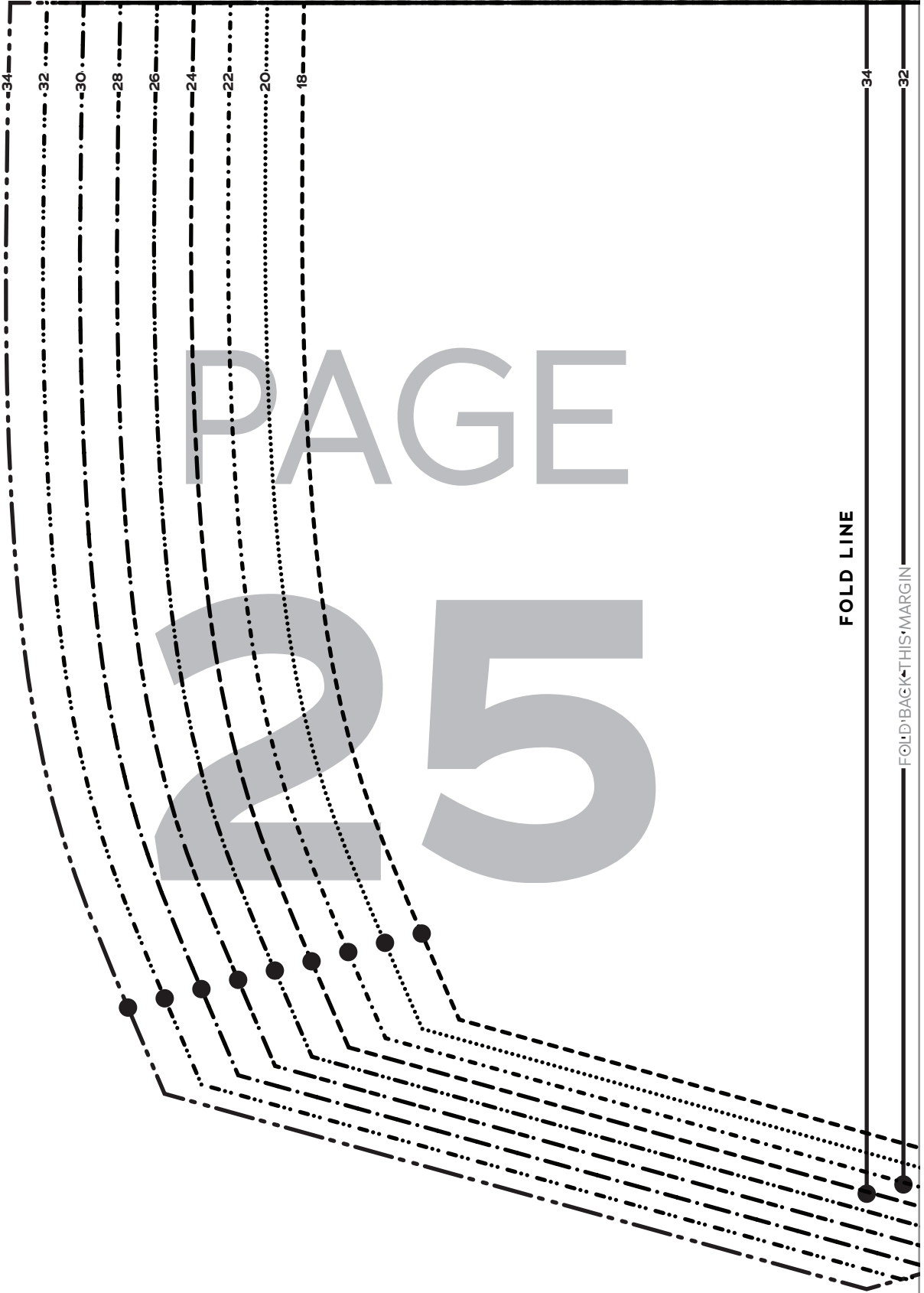

FOLD LINE

FOLD BACK THIS MARGIN

FOLD BACK THIS MARGIN

B1

B2

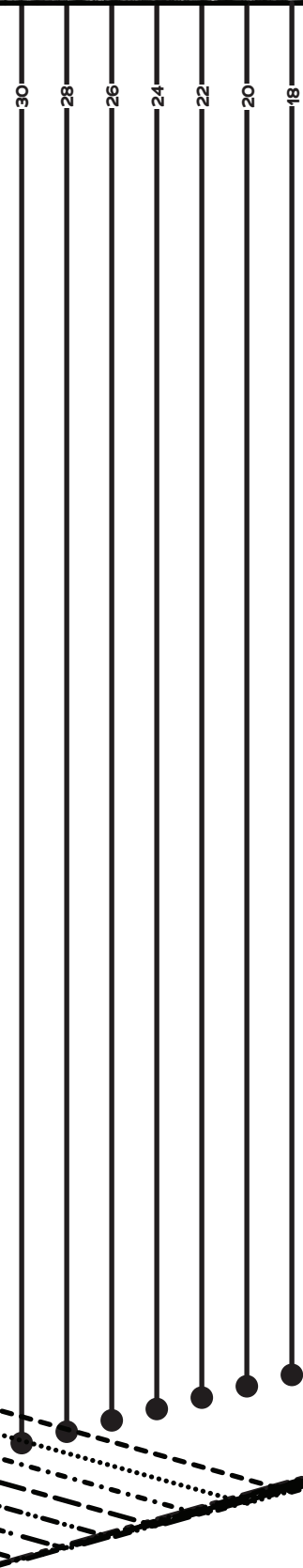

PAGE
26

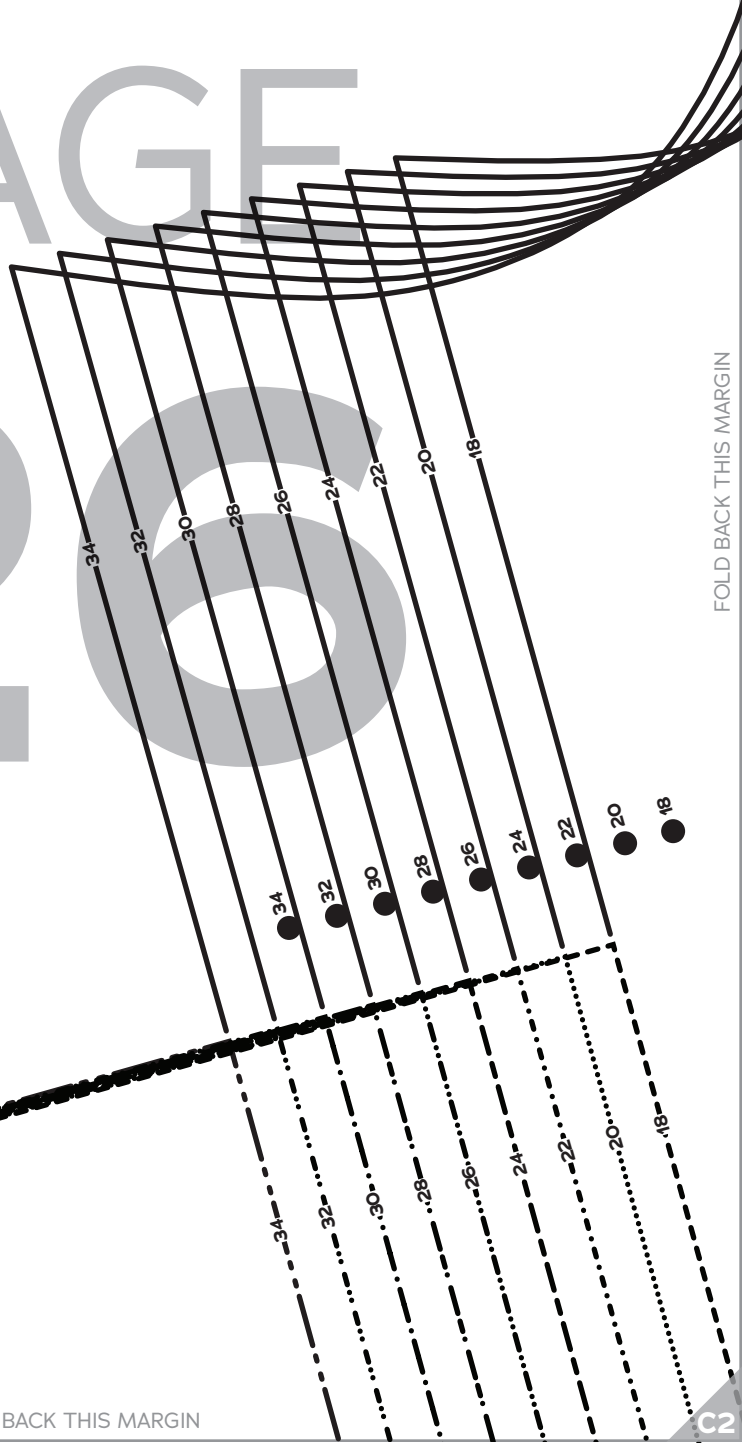

C1

FOLD BACK THIS MARGIN

C2

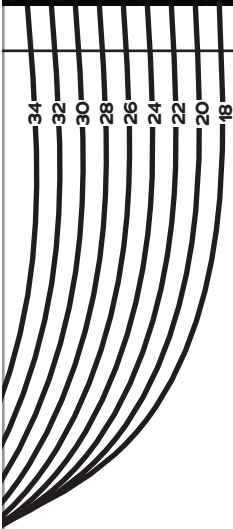

**BARBIE TOP
ALTERNATIVE
NECKLINE**

PAGE

27

FOLD BACK THIS MARGIN

FOLD

PAGE

Society
of CHARM
Francie

TOP

SIZES 18-34

1

Top Front,
F-H Cups

Cut 1 fabric on fold

28

FOLD BACK THIS MARGIN

B4

B5



18
20
22
24
26
28
30
32
34

PAGE 29

WAISTLINE

FOLD BACK THIS MARGIN

C4

FOLD BACK THIS MARGIN

C5

PAGE 30

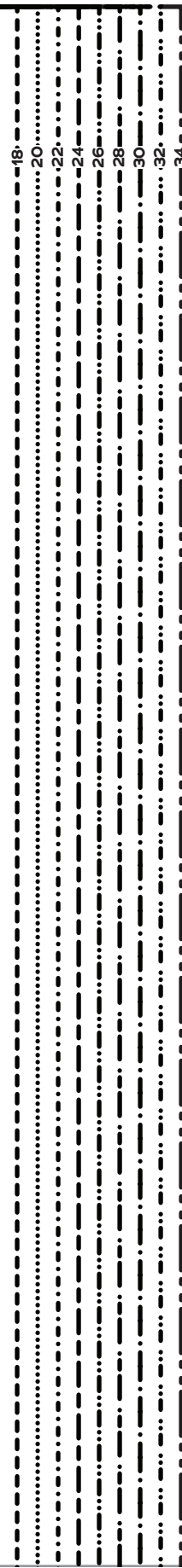

FOLD BACK THIS MARGIN

B6

B7

PAGE 31

FOLD BACK THIS MARGIN

FOLD BACK THIS MARGIN

C7

B7

B8

PAGE

32

34
32
30
28
26
24
22
20
18

THREE-QUARTER SLEEVE CUTTING LINE

FOLD BACK THIS MARGIN

C7

FOLD BACK THIS MARGIN

C8

B8

B9

22

20

18

PAGE

Society
of CHARM

Francie

TOP

SIZES 18-34

333

Sleeve Front,
F-H Cups

Cut 2 fabric

FOLD BACK THIS MARGIN

C8

FOLD BACK THIS MARGIN

C9

B9

B10

GRAINLINE

PAGE

34

FOLD BACK THIS MARGIN

FOLD BACK THIS MARGIN

C9

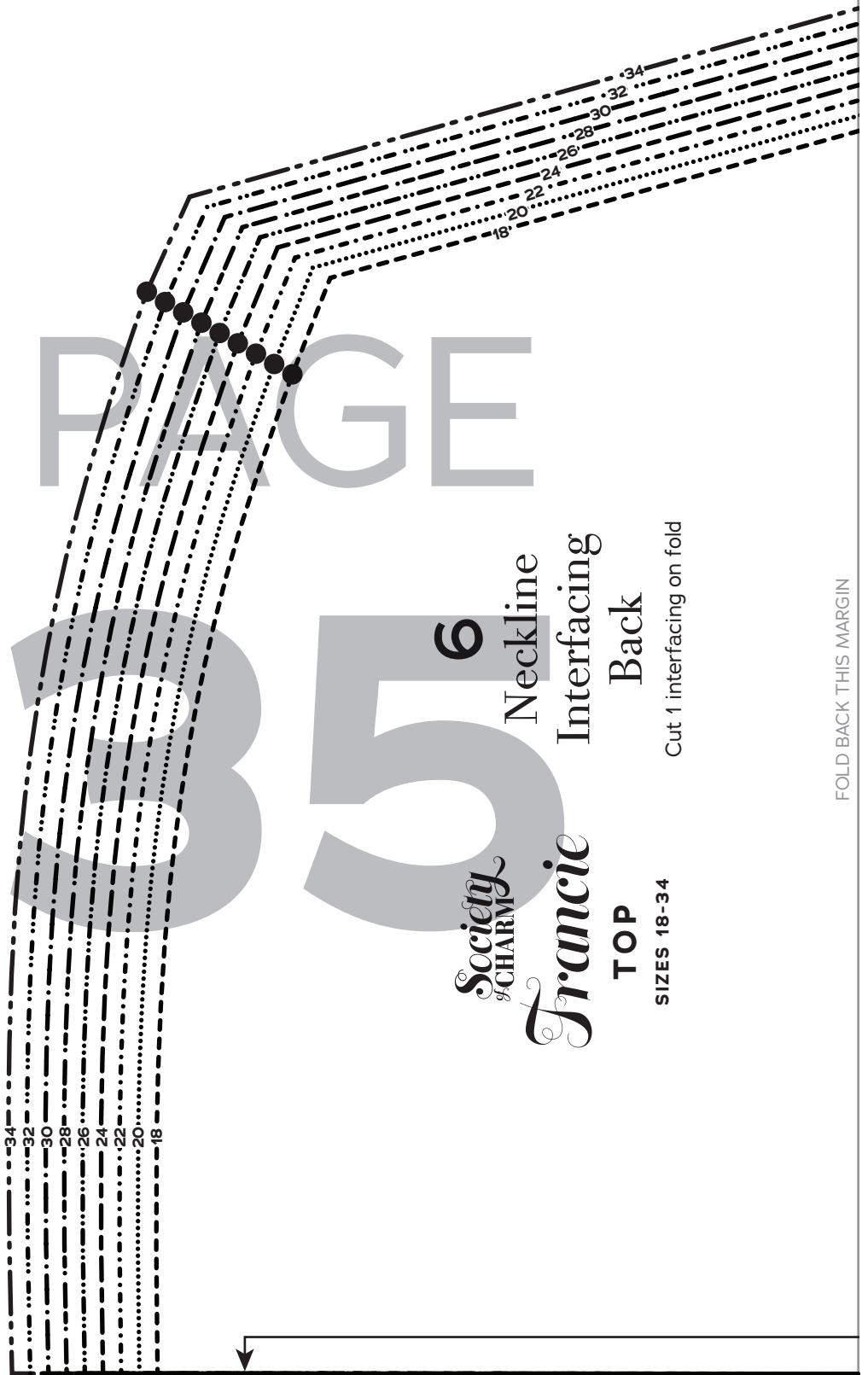

Society of CHARM
Francie

6
 Neckline
 Interfacing
 Back

TOP
 SIZES 18-34

Cut 1 interfacing on fold

FOLD BACK THIS MARGIN

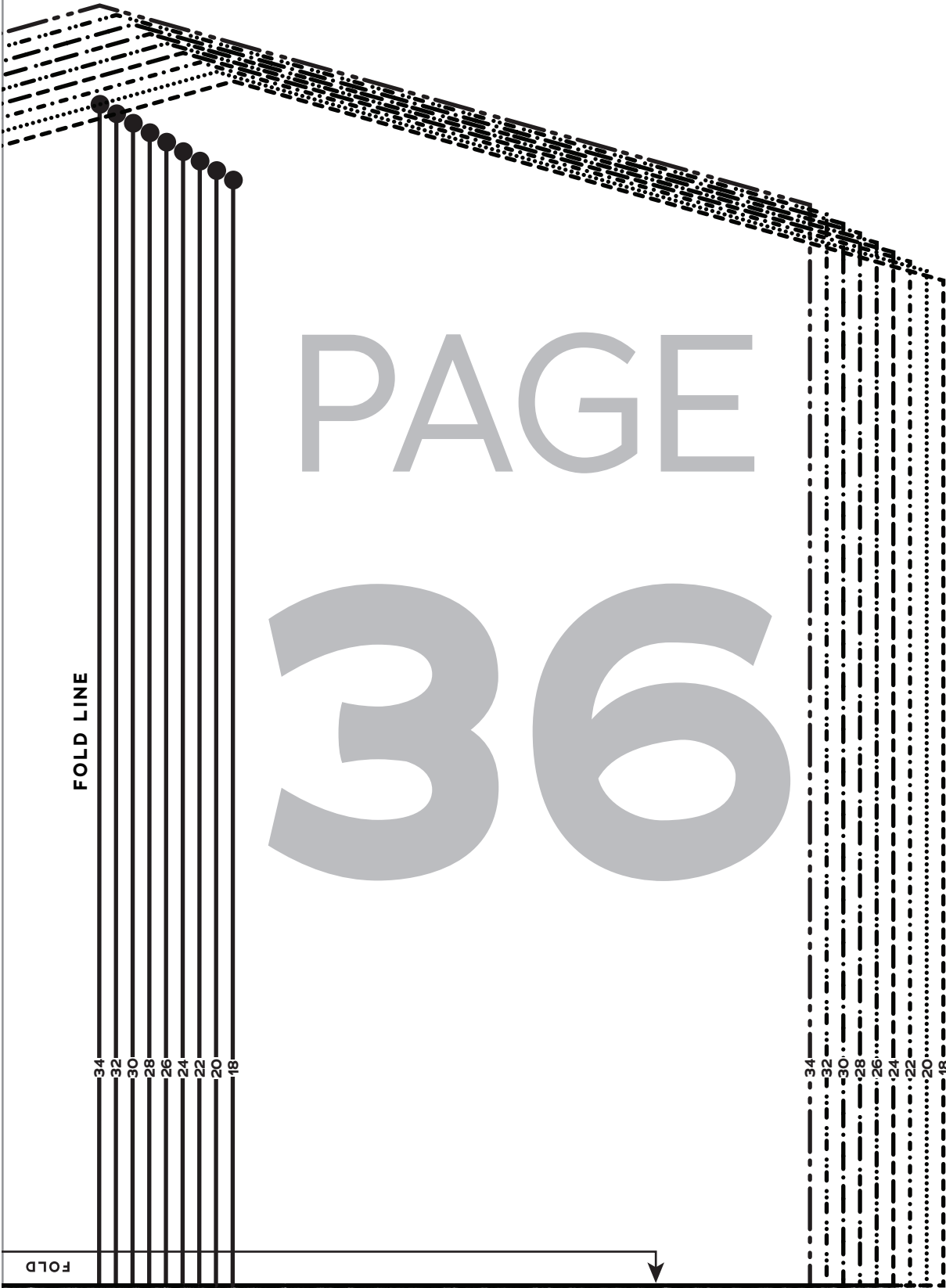

PAGE

37

FOLD BACK THIS MARGIN

34

32

30

28

26

24

22

20

18

FOLD BACK THIS MARGIN

C1

C2

PAGE

38

FOLD BACK THIS MARGIN

FOLD BACK THIS MARGIN

D1

D2

C2

C3

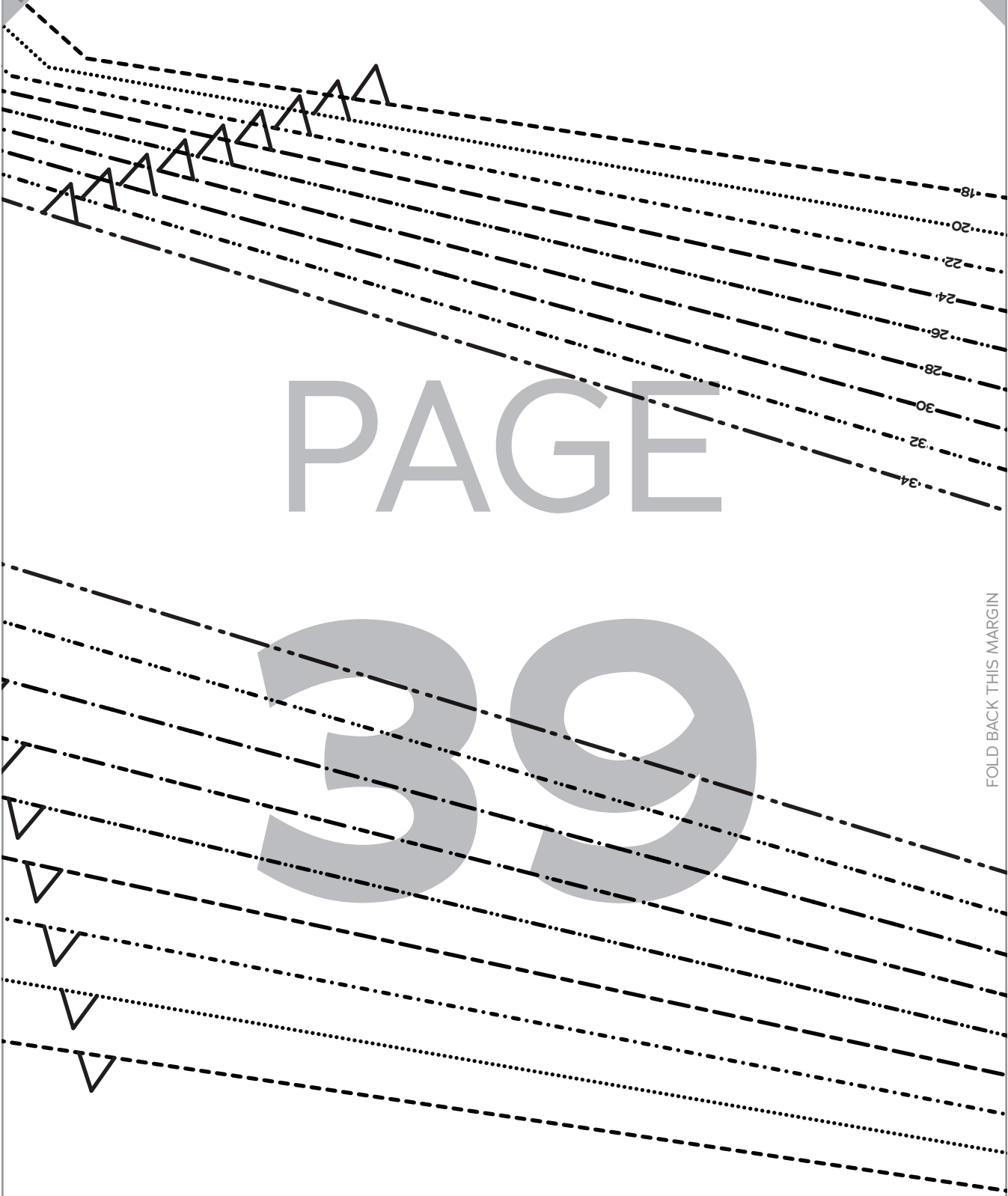

PAGE

39

FOLD BACK THIS MARGIN

D2

FOLD BACK THIS MARGIN

D3

C3

C4

PAGE

40

FOLD BACK THIS MARGIN

34

32

30

28

26

24

22

20

18

D3

FOLD BACK THIS MARGIN

D4

C4

C5

PAGE

41

FOLD BACK THIS MARGIN

D4

FOLD BACK THIS MARGIN

D5

C5

C6

PAGE

42

FOLD BACK THIS MARGIN

D5

FOLD BACK THIS MARGIN

D6

C6

C7

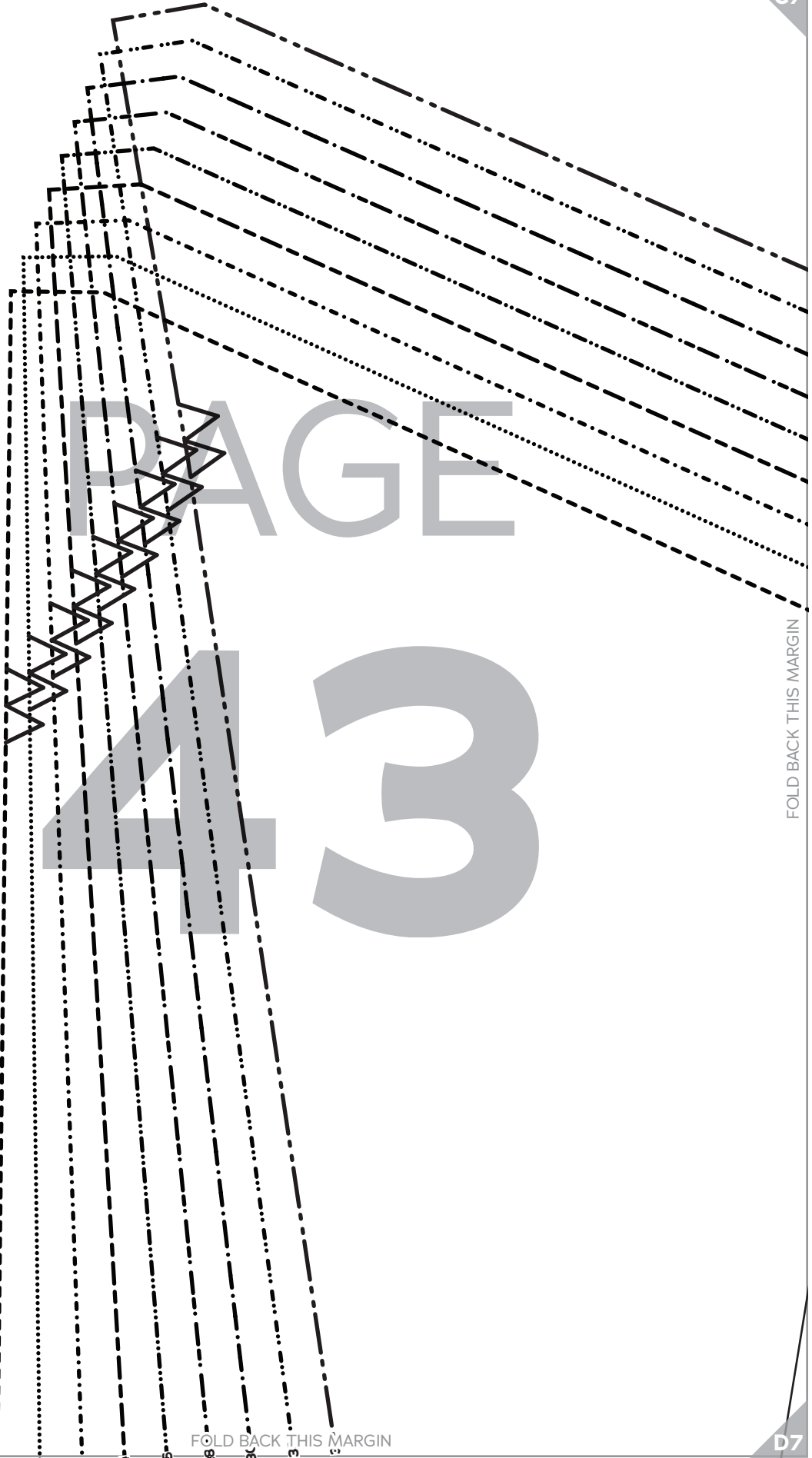

FOLD BACK THIS MARGIN

FOLD BACK THIS MARGIN

D6

D7

C7

C8

PAGE

44

FOLD BACK THIS MARGIN

30

28

26

24

22

20

18



D7

FOLD BACK THIS MARGIN

D8

C8

C9

PAGE

45

FOLD BACK THIS MARGIN

34

32

30

28

26

24

22

20

18

G LINE

18

20

22

24

26

28

30

32

34

FOLD BACK THIS MARGIN

D8

D9

C9

PAGE

46

D9

FOLD BACK THIS MARGIN

PAGE 47

18
20
22
24
26
28
30
32
34

FOLD BACK THIS MARGIN

D1

D2

PAGE

58

WAISTLINE

FOLD BACK THIS MARGIN

18
20
22
24
26
28
30
32
34



PAGE

Francie
 Society of CHARM
TOP
 SIZES 18-34
1
 Top Front,
 A-D/DD Cups
 Cut 1 fabric on fold

FOLD BACK THIS MARGIN

FOLD

PAGE 50

FOLD BACK THIS MARGIN

**BARBIE TOP
ALTERNATIVE
NECKLINE**

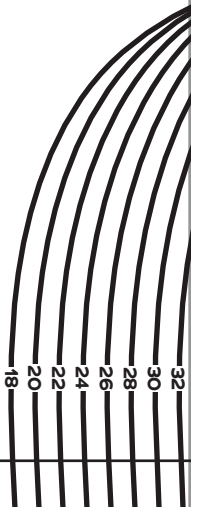

D4

D5

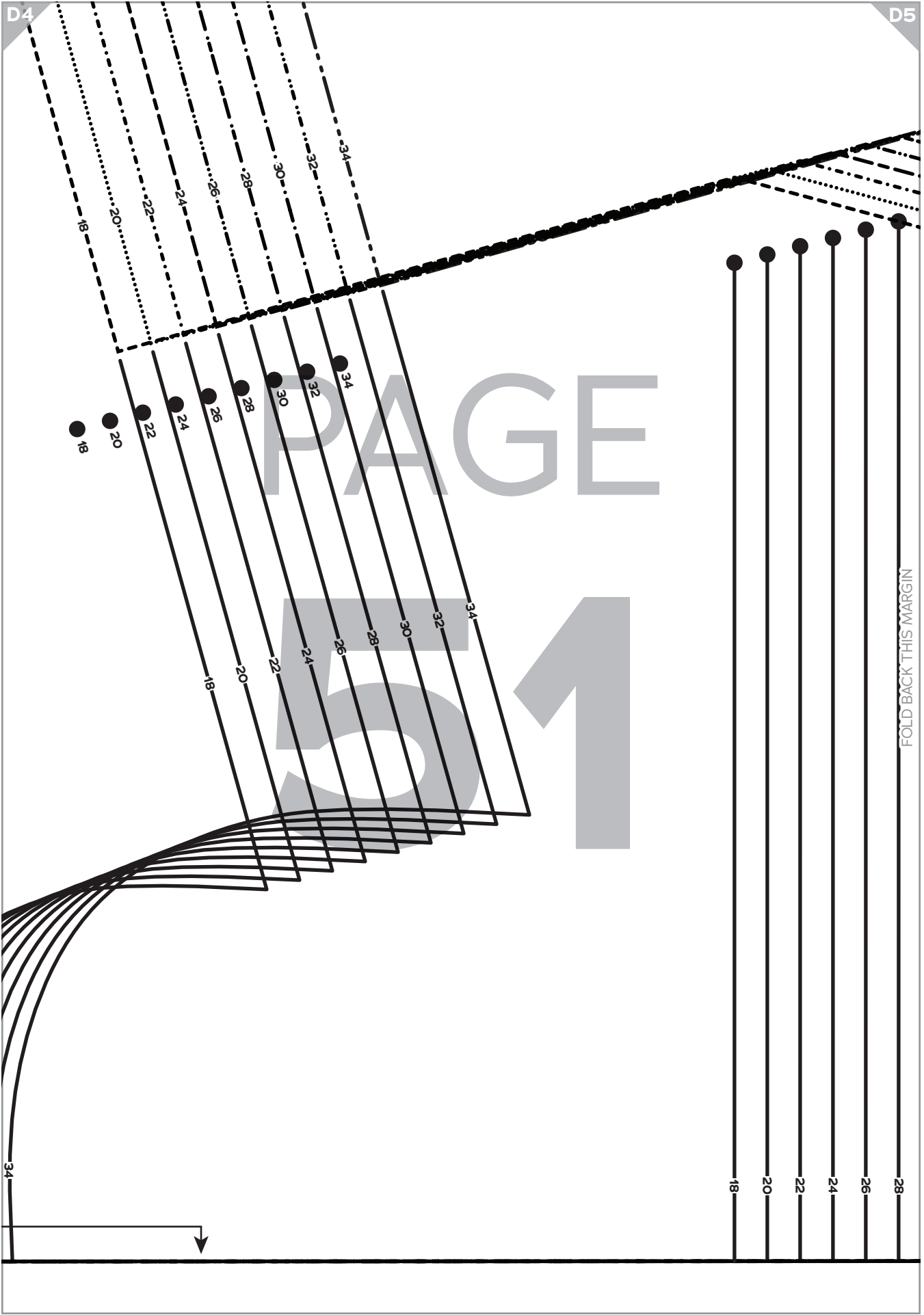

D5

D6

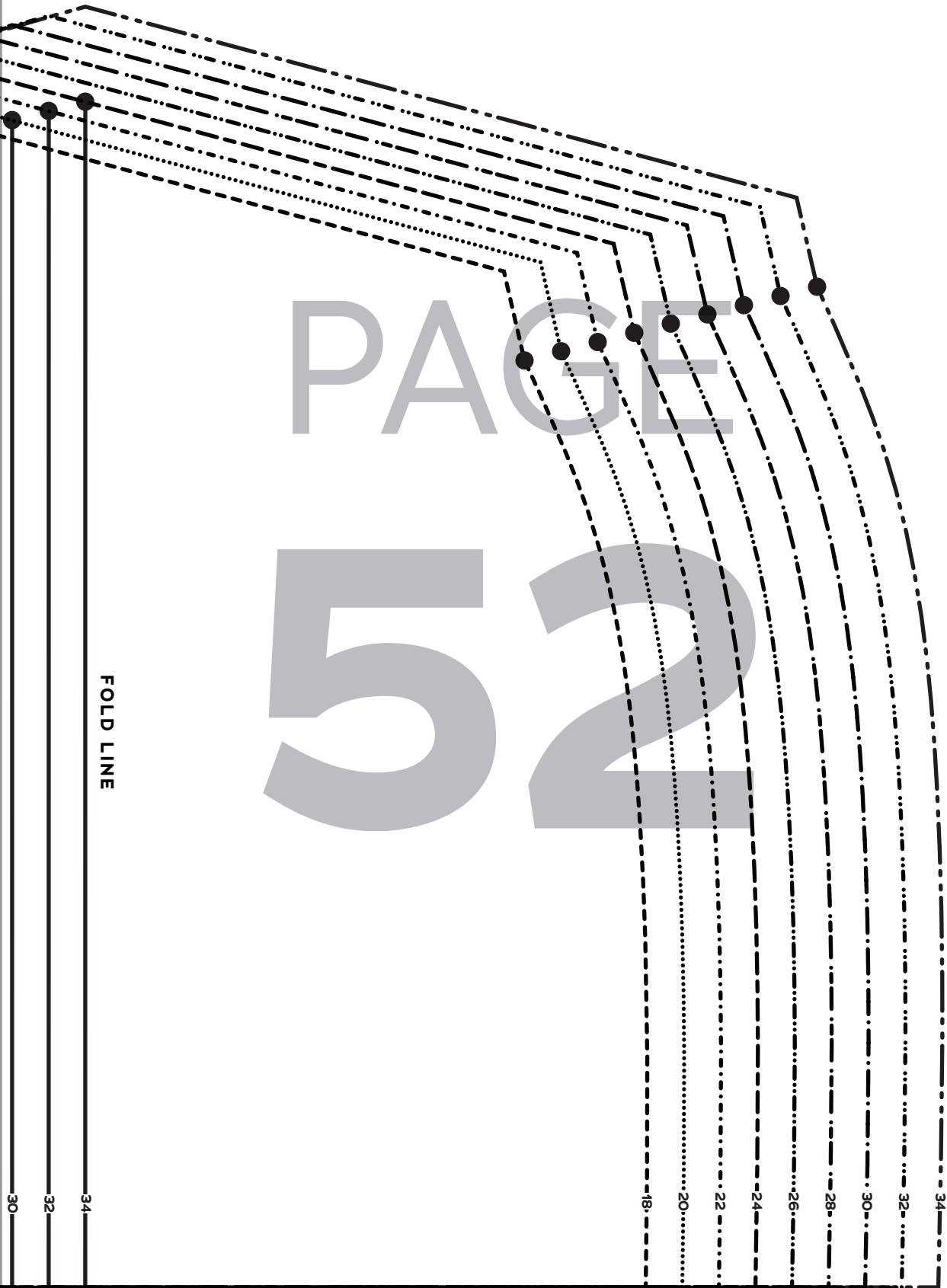

FOLD LINE

FOLD BACK THIS MARGIN

D6

D7

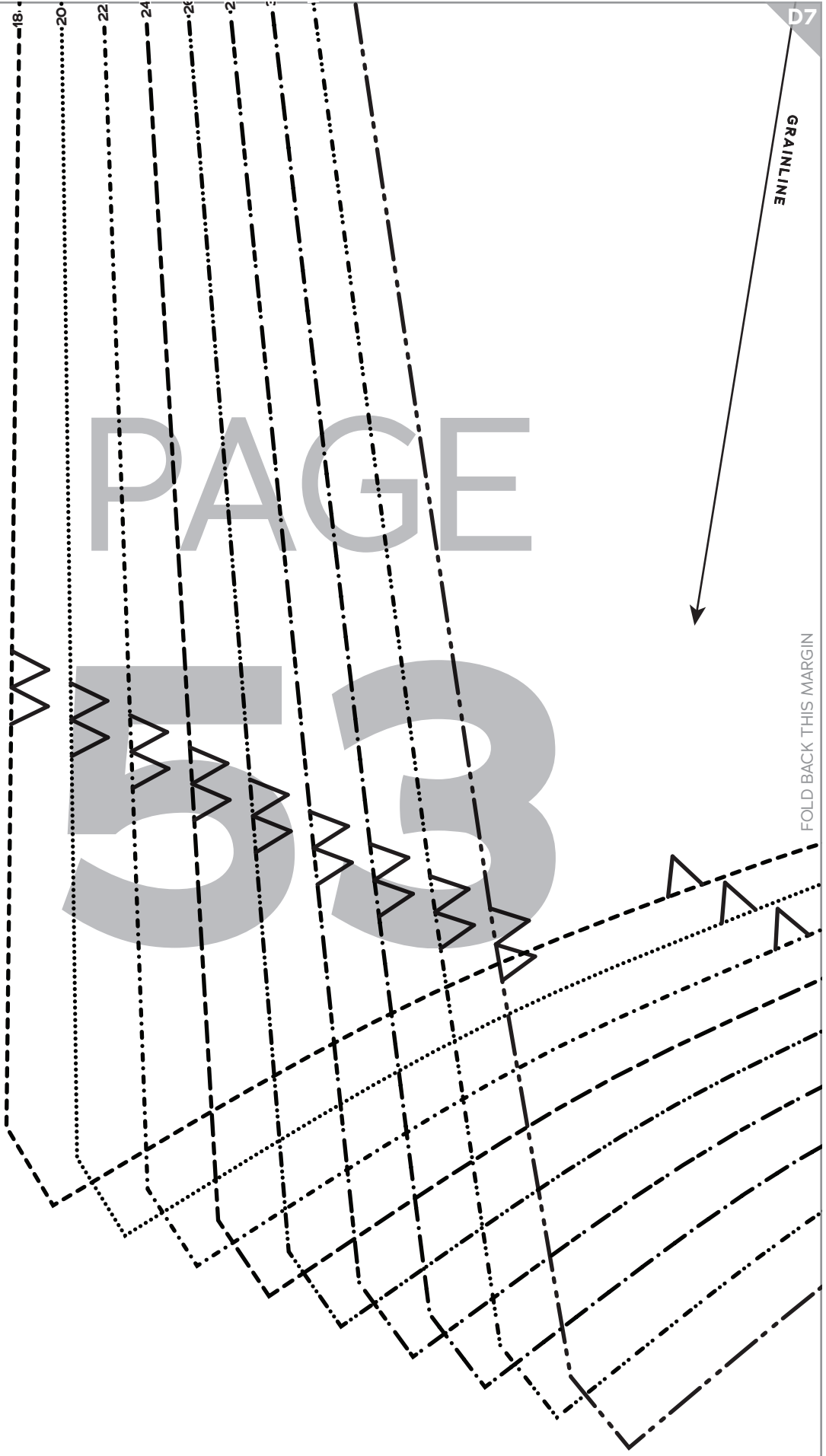

GRAINLINE

FOLD BACK THIS MARGIN

PAGE 53

D7

D8

*Society
of CHARM*
Francie
TOP
SIZES 18-34

4
Sleeve Back
Cut 2 fabric

PAGE

54

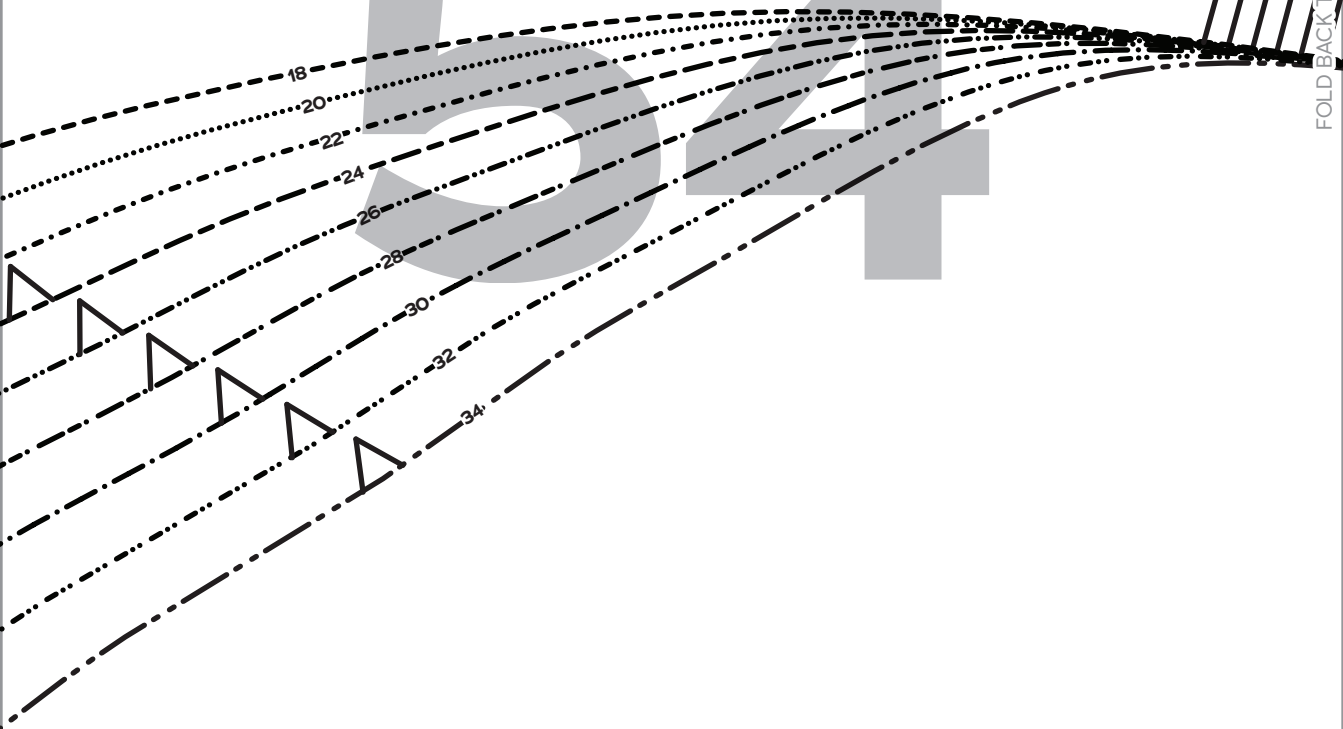

D8

D9

THREE-QUARTER SLEEVE CUTTING

PAGE

55

FOLD BACK THIS MARGIN

D9

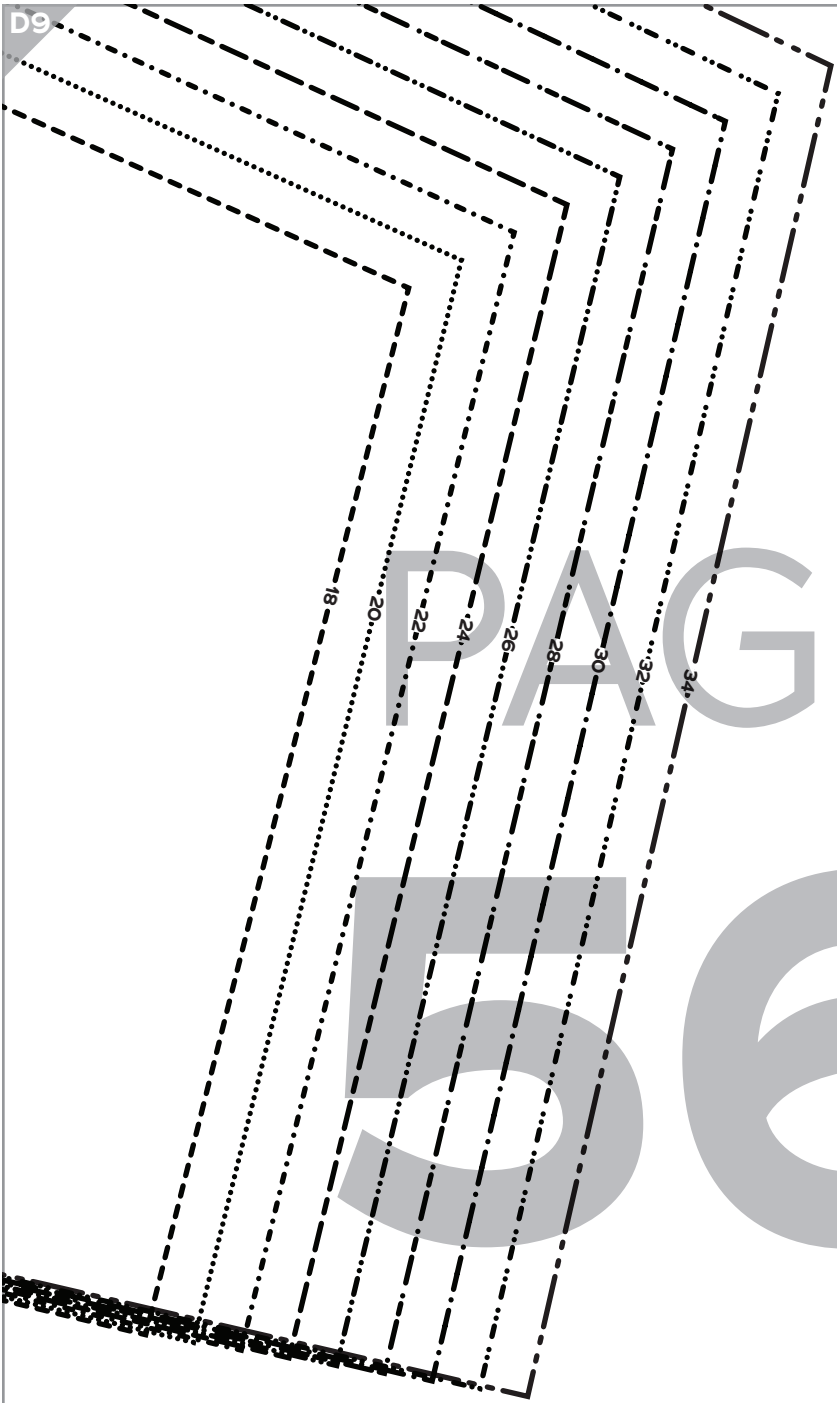

PAGE
56