

CHARM PATTERNS

STANWYCK BODICE AND COLLAR

Sizes 18-34
with cup sizes A-H

5/8 inch (in) (1.5 cm) seam allowances are included on all pattern pieces.

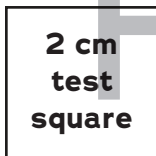
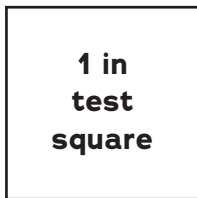

SIZES 18-34 PATTERN SIZE KEY

18	-----
20
22	-----
24	-----
26	-----
28	-----
30	-----
32	-----
34	-----

SYMBOL KEY

grainline arrow



match point/
placement mark



© 2023 Charm Patterns
by Gertie. Distribution
and Commercial Use
Prohibited.

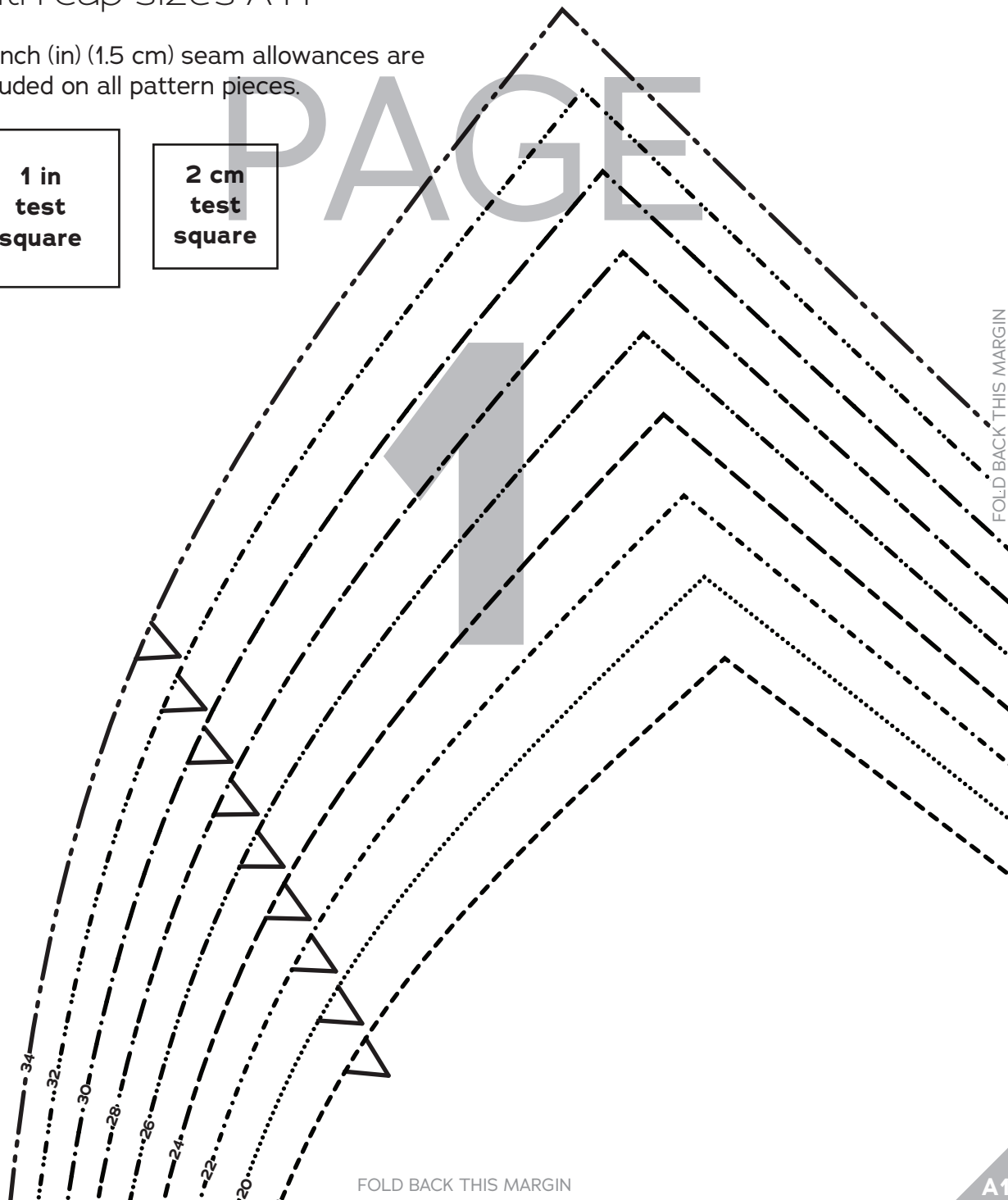

FOLD BACK THIS MARGIN

FOLD BACK THIS MARGIN

A1

PAGE

2

FOLD BACK THIS MARGIN

34

32

30

28

26

24

22

20

18

A1

FOLD BACK THIS MARGIN

A2

PAGE

3

FOLD BACK THIS MARGIN

A2

FOLD BACK THIS MARGIN

A3

FOLD BACK THIS MARGIN

PAGE

4

FOLD BACK THIS MARGIN

A3

FOLD BACK THIS MARGIN

A4

PAGE
5

FOLD BACK THIS MARGIN

A4

FOLD BACK THIS MARGIN

A5

PAGE

6

FOLD BACK THIS MARGIN

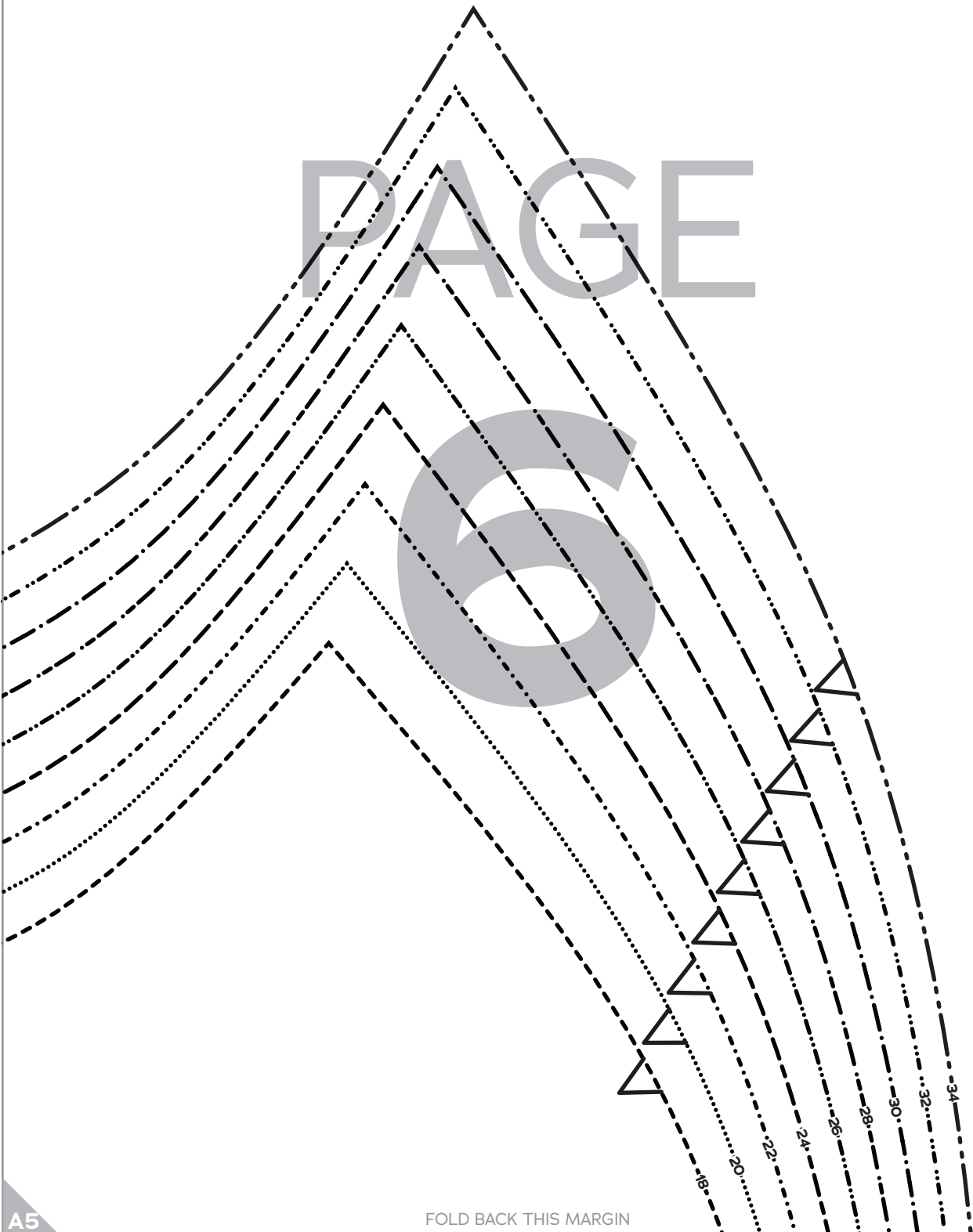

A5

FOLD BACK THIS MARGIN

A6

PAGE

7

FOLD BACK THIS MARGIN

A6

FOLD BACK THIS MARGIN

A7

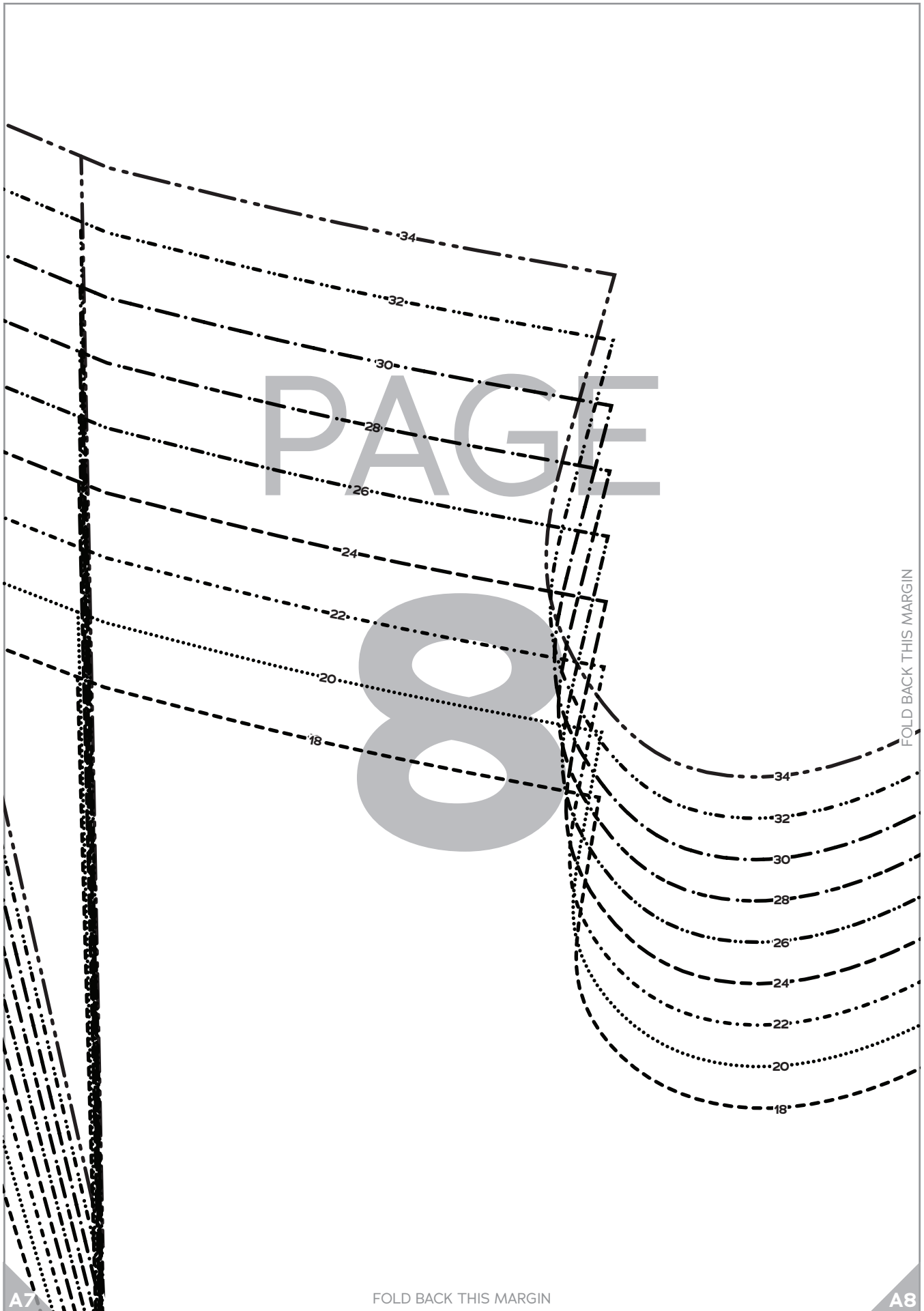

PAGE

8

FOLD BACK THIS MARGIN

A7

FOLD BACK THIS MARGIN

A8

PAGE

9

FOLD BACK THIS MARGIN

A8

FOLD BACK THIS MARGIN

A9

PAGE

10

FOLD BACK THIS MARGIN

A9

FOLD BACK THIS MARGIN

A10

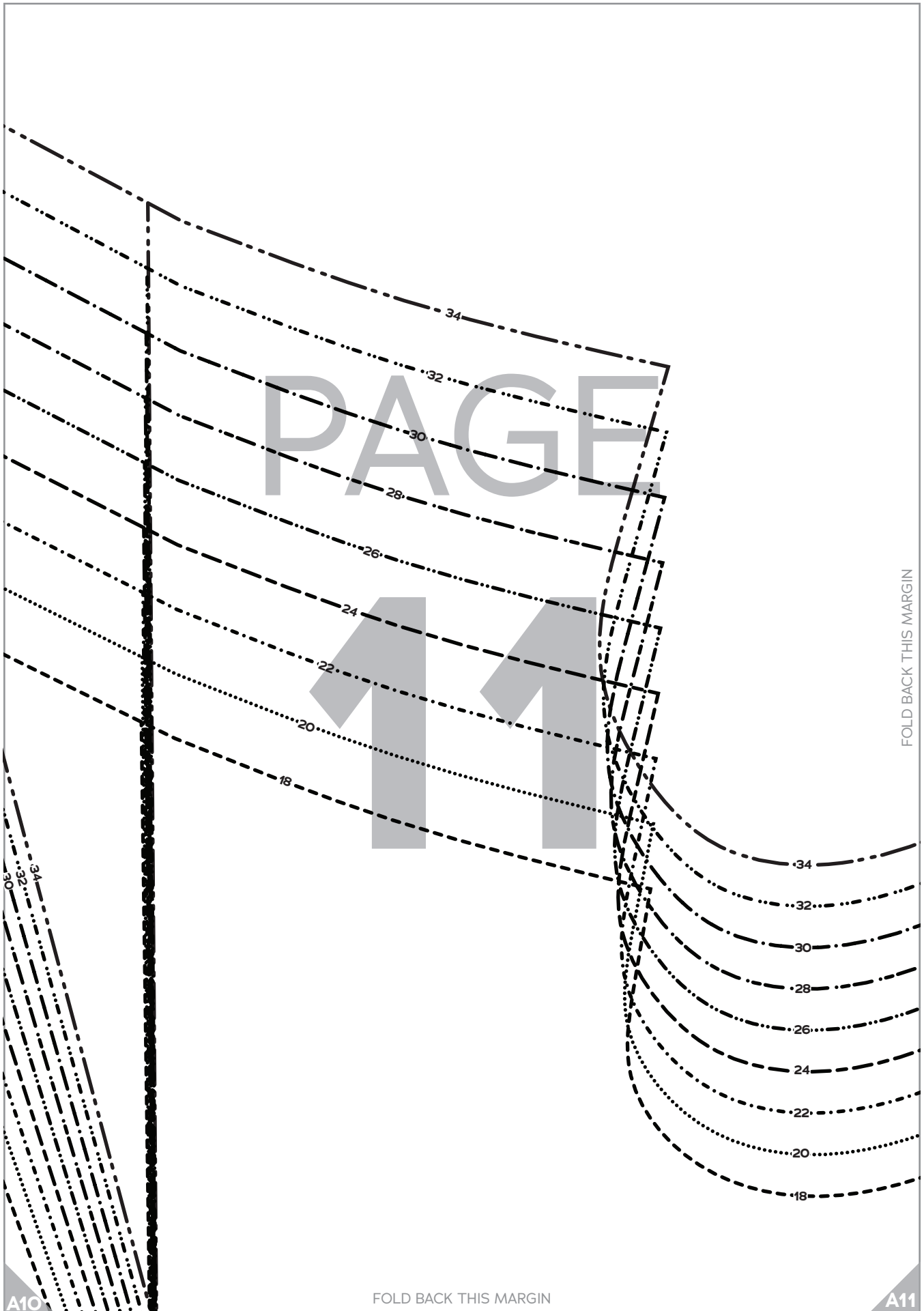

A10

FOLD BACK THIS MARGIN

A11

PAGE

12

A11

FOLD BACK THIS MARGIN

PAGE 13

FOLD BACK THIS MARGIN



34
32
30
28
26
24
22
20
18



**COLLAR
PLACEMENT
MARK**

FOLD BACK THIS MARGIN

A1

A2

CHARM
PATTERNS



**STANWYCK BODICE
AND COLLAR
SIZES 18-34**



Bodice Back

Cut 2 fabric, 2 lining

PAGE

14

18 20 22 24 26 28 30 32 34

FOLD BACK THIS MARGIN

GRAINLINE

B1

FOLD BACK THIS MARGIN

B2

A2

A3

PAGE

15

FOLD BACK THIS MARGIN



B2

FOLD BACK THIS MARGIN

B3

A3

A4

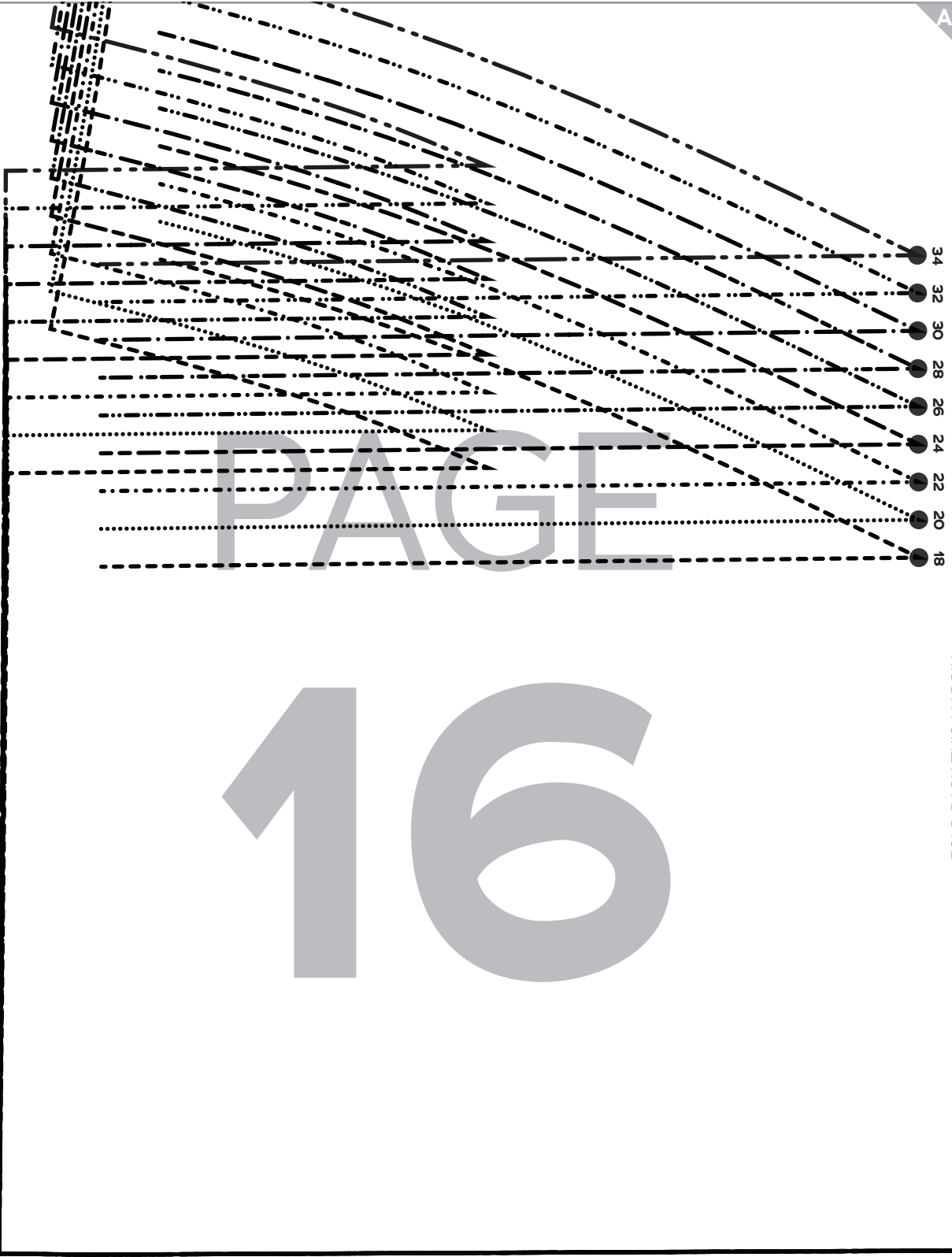

FOLD BACK THIS MARGIN

B3

FOLD BACK THIS MARGIN

B4

A4

A5



PAGE 17

CHARM
PATTERNS
by Gertie
**STANWYCK BODICE
AND COLLAR
SIZES 18-34**

Bodice Front, A/B Cup
Cut 1 fabric on fold, 1 lining on fold

FOLD BACK THIS MARGIN



B4

FOLD BACK THIS MARGIN

B5

A5

A6

PAGE 18

FOLD BACK THIS MARGIN

34
32
30
28
26
24
22
20
18

B5

FOLD BACK THIS MARGIN

B6

A6

A7

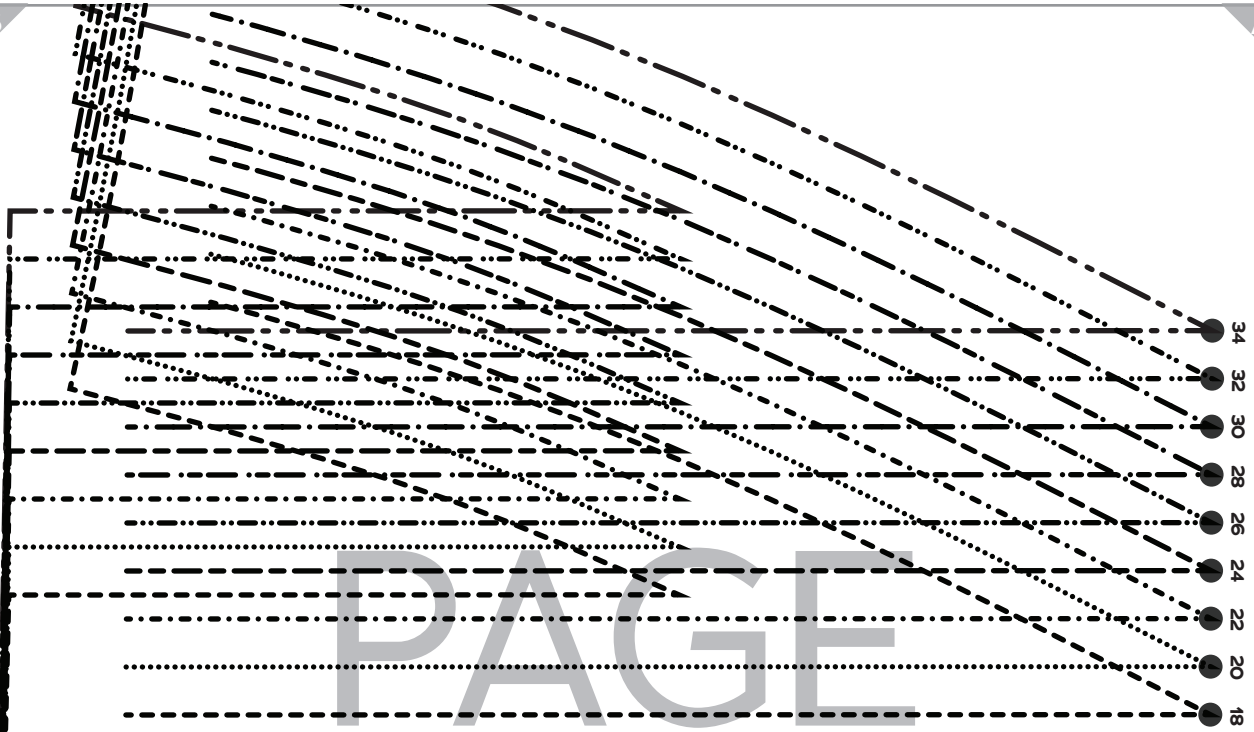

PAGE

19

FOLD BACK THIS MARGIN

B6

FOLD BACK THIS MARGIN

B7

A7

A8



PAGE 20

CHARM
PATTERNS by Gertie

**STANWYCK
BODICE AND COLLAR
SIZES 18-34**

Bodice Front, C Cup

Cut: 1 fabric on fold, 1 lining on fold

FOLD BACK THIS MARGIN



B7

B8

FOLD BACK THIS MARGIN

A8

A9

PAGE 21

FOLD BACK THIS MARGIN

18	20	22	24	26	28	30	32	34
----	----	----	----	----	----	----	----	----

B8

FOLD BACK THIS MARGIN

B9

A9

A10

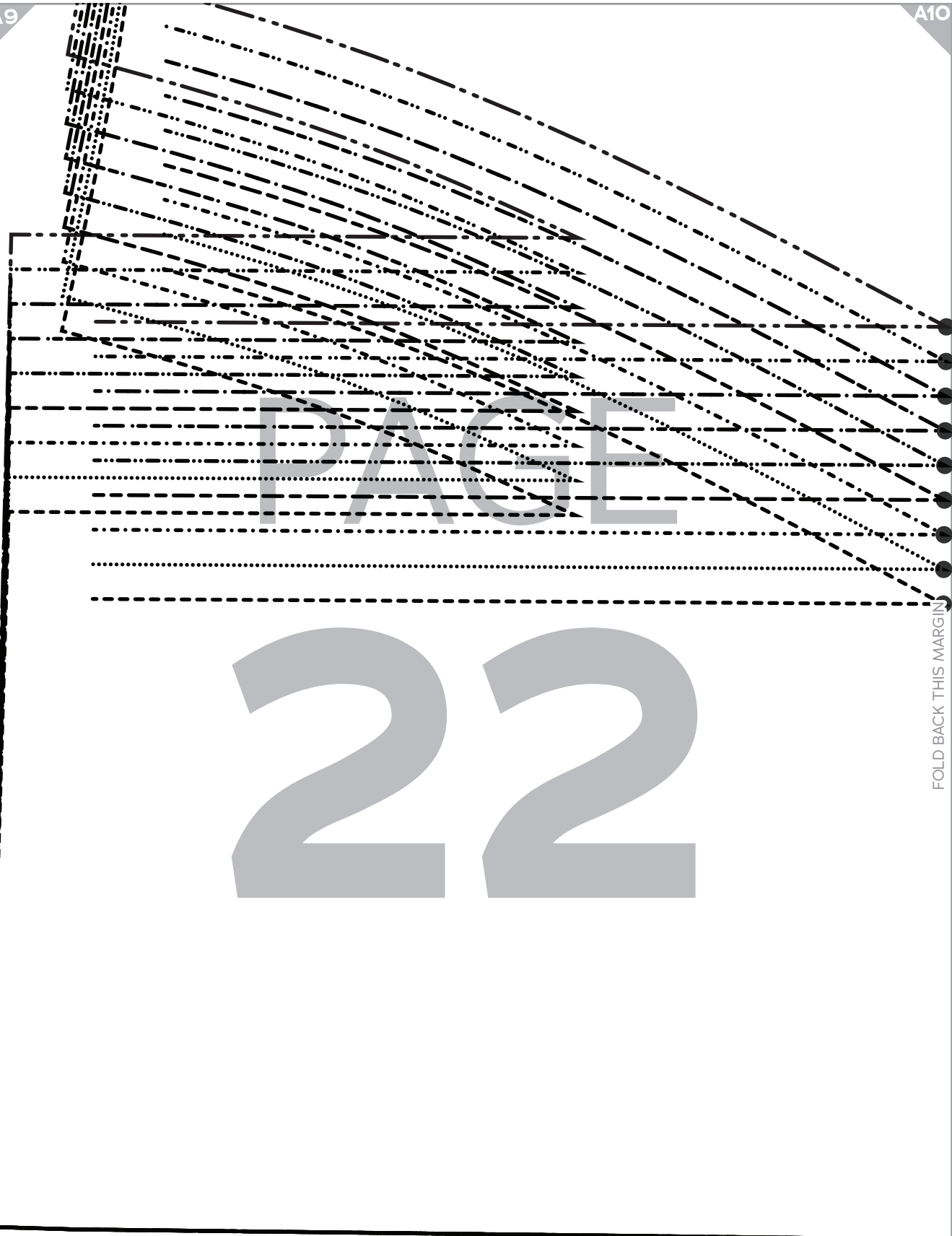

FOLD BACK THIS MARGIN

FOLD BACK THIS MARGIN

B9

B10

A11

FOLD BACK THIS MARGIN

B11



**STANWYCK BODICE
AND COLLAR
SIZES 18-34**

Bodice Front, D/DD Cup
Cut 1 fabric on fold, 1 lining on fold

PAGE
23

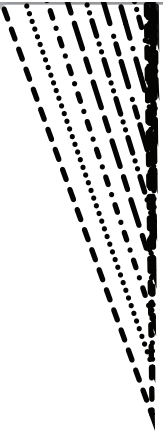

A10

34 32 30 28 26 24 22 20 18

FOLD

FOLD BACK THIS MARGIN

B10

A11

PAGE

24



B11

PAGE

25

FOLD BACK THIS MARGIN

FOLD BACK THIS MARGIN

B1

B2

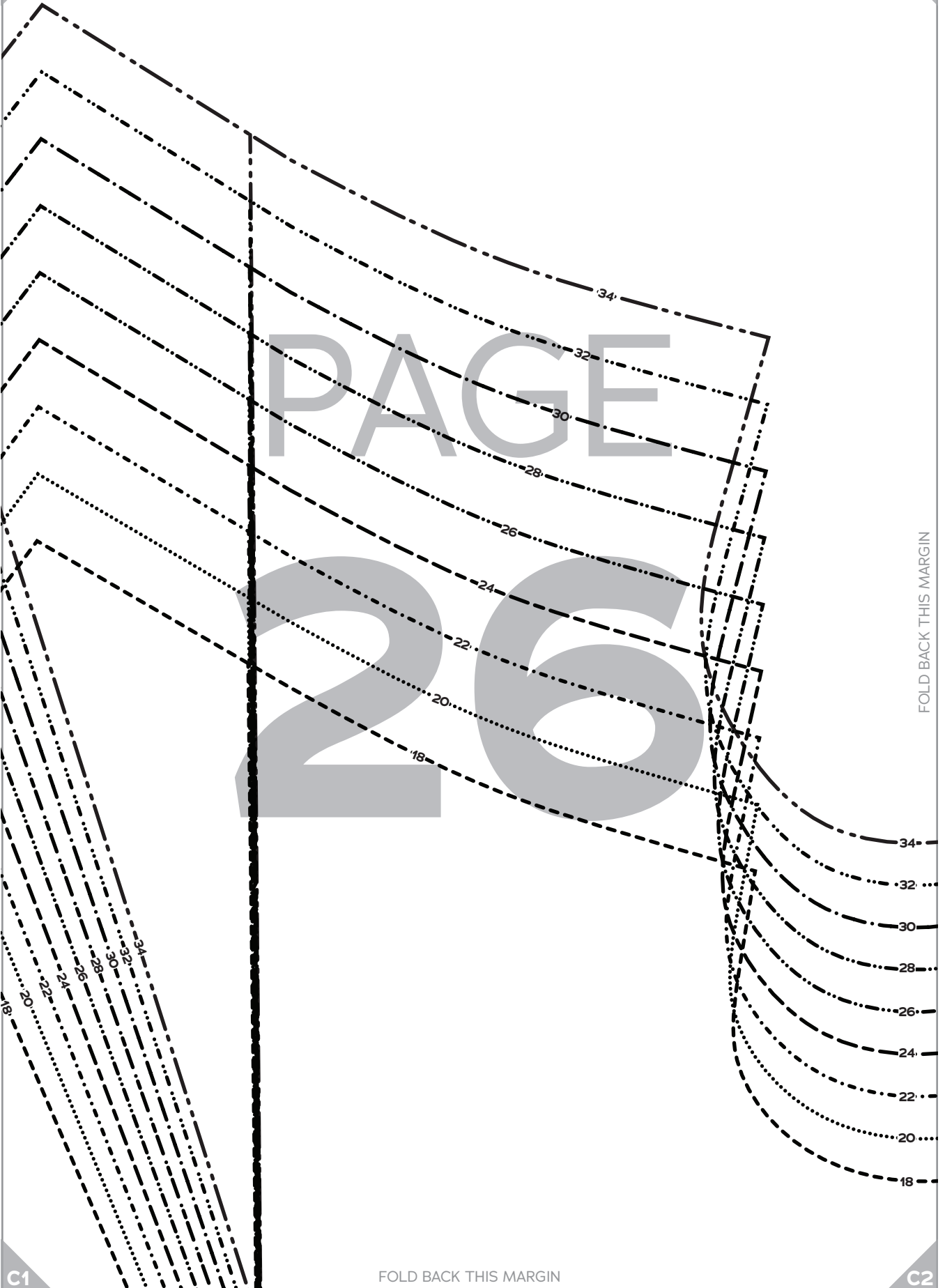

PAGE

26

FOLD BACK THIS MARGIN

FOLD BACK THIS MARGIN

B2

B3

PAGE

27

FOLD BACK THIS MARGIN

C2

FOLD BACK THIS MARGIN

C3

B3

B4

PAGE

28

FOLD BACK THIS MARGIN

FOLD BACK THIS MARGIN

C3

C4

PAGE

30

FOLD BACK THIS MARGIN

34
32
30
28
26
24
22
20
18

FOLD BACK THIS MARGIN

PAGE
31

34 26 18

MATCH
TO BODICE
COLLAR
PLACEMENT
MARK

FOLD BACK THIS MARGIN

FOLD BACK THIS MARGIN

PAGE

32

GRAINLINE

CHARM PATTERNS by Gertie

3 STANWYCK BODICE AND COLLAR SIZES 18-34

Collar

Cut 4 fabric, 2 interfacing

FOLD BACK THIS MARGIN

PAGE

33

FOLD BACK THIS MARGIN





FOLD BACK THIS MARGIN

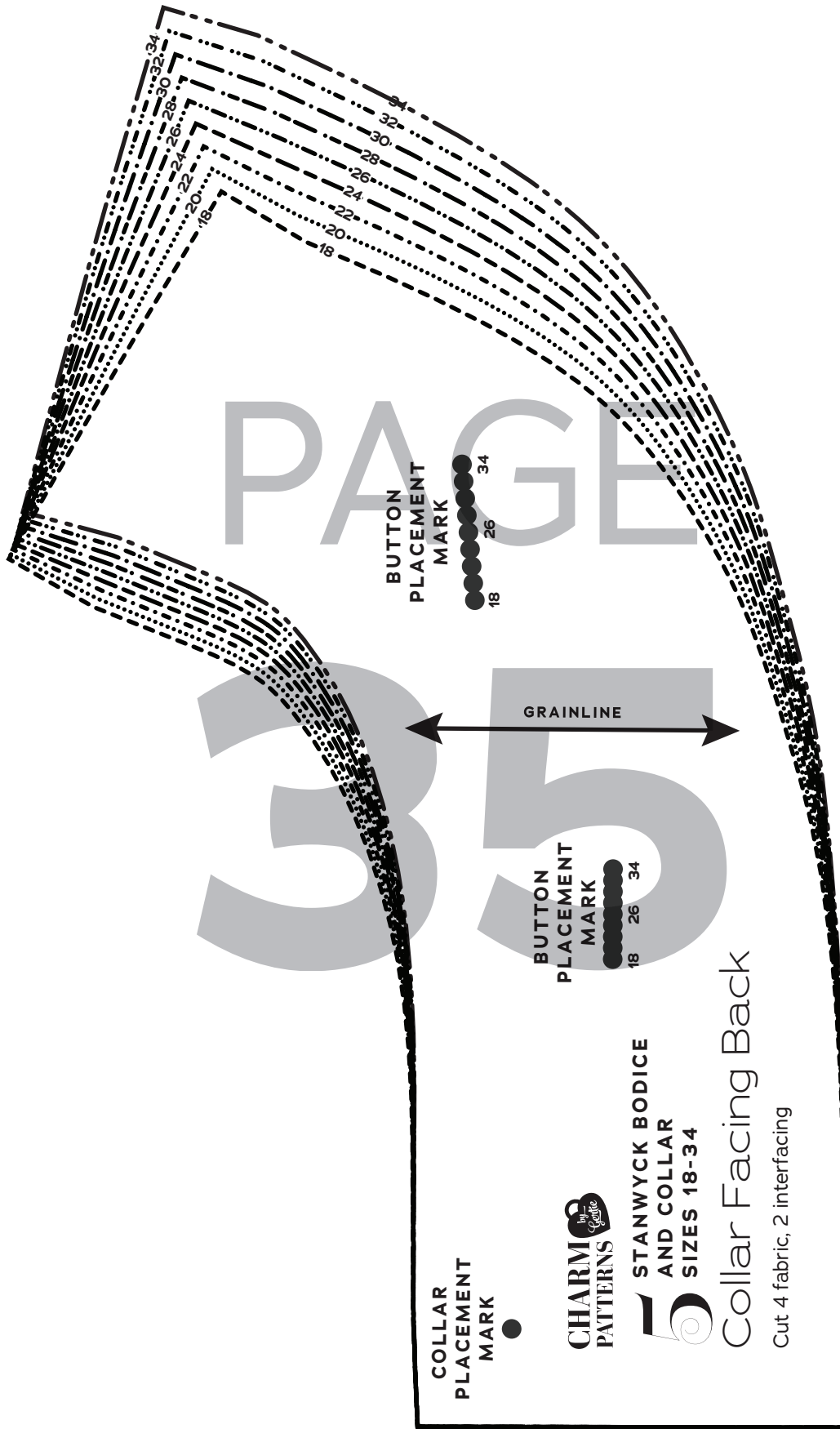

COLLAR
PLACEMENT
MARK

CHARM
PATTERNS

5 STANWYCK BODICE
AND COLLAR
SIZES 18-34

Collar Facing Back

Cut 4 fabric, 2 interfacing

BUTTON
PLACEMENT
MARK

GRAINLINE

BUTTON
PLACEMENT
MARK

PAGE

35

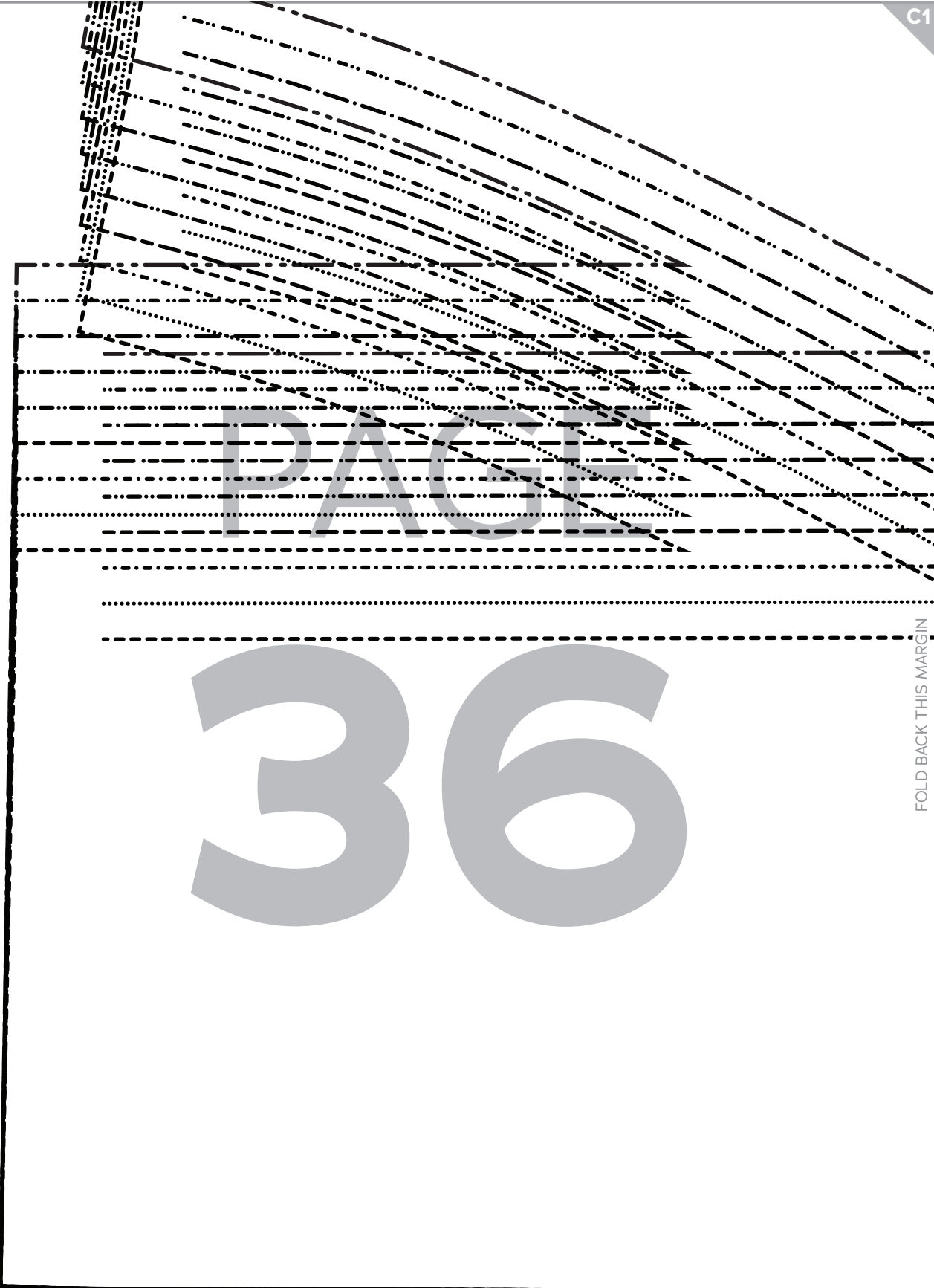

FOLD BACK THIS MARGIN

FOLD BACK THIS MARGIN

C2

C1



**STANWYCK BODICE
AND COLLAR
SIZES 18-34**

Bodice Front, F/G Cup

Cut 1 fabric on fold, 1 lining on fold

PAGE
37

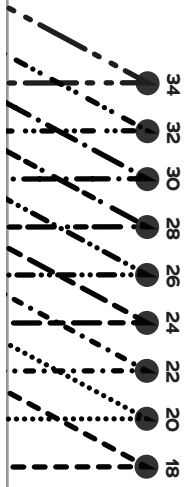

C2

C3

PAGE

38

FOLD BACK THIS MARGIN

34
32
30
28
26
24
22
20
18

C3

C4

PAGE

39

FOLD BACK THIS MARGIN

C4

C5

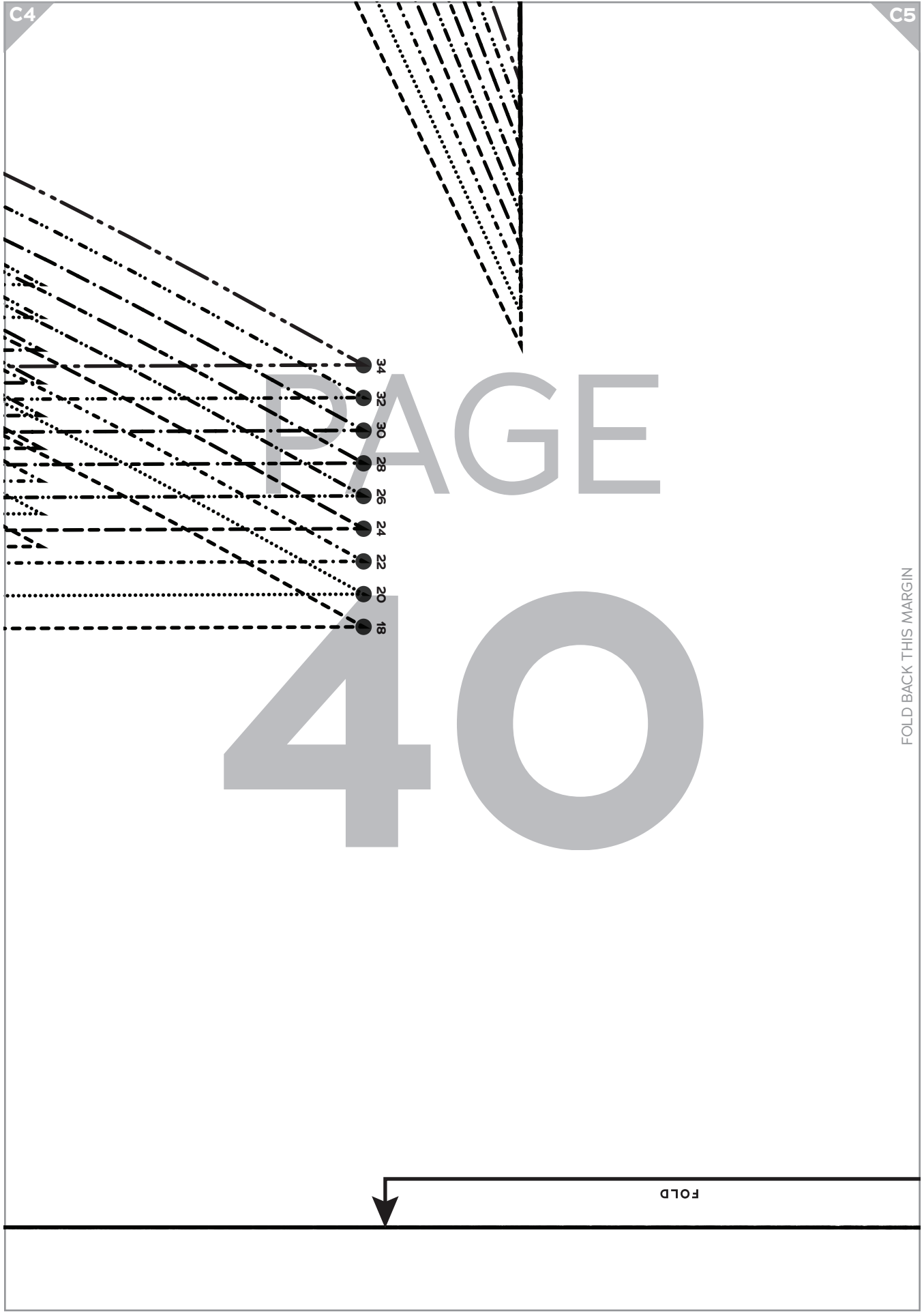

FOLD BACK THIS MARGIN

FOLD

PAGE 41



**CHARM
PATTERNS**

**STANWYCK BODICE
AND COLLAR
SIZES 18-34**

**Bodice Front, H
Cup**

FOLD BACK THIS MARGIN

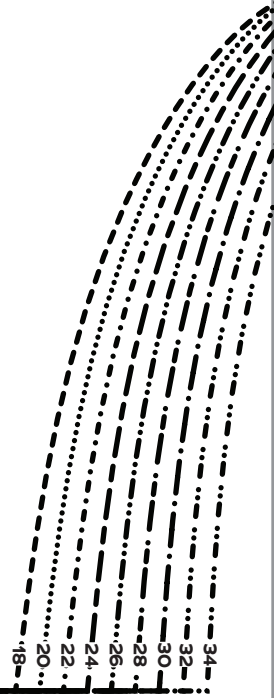

C6

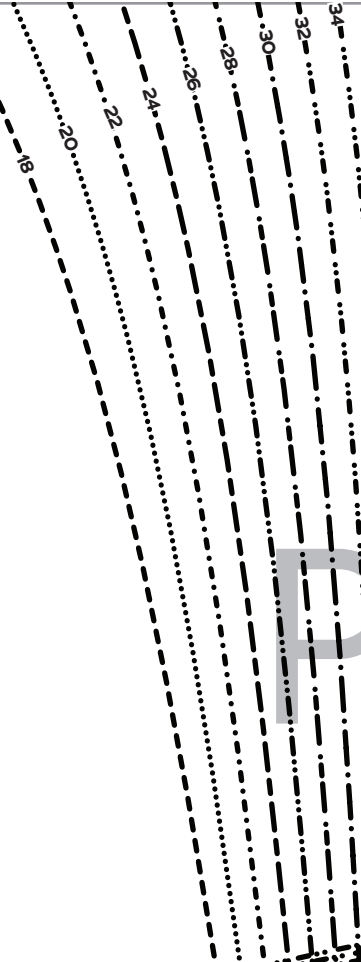

PAGE

42